

RUBY SERIES GRILL BY SUNSTONE® USE & CARE GUIDE

Read all instructions before you operate your grill.
Save these instructions!



Conforms to
ANSI STD Z21.58b-2012
Certified to CSA STD 1.6b-2012
Outdoor Cooking Gas Appliance

3174816

To installer or person assembling grill: Leave this manual with grill for future reference.
To consumer: Keep this manual for future reference.

www.sunstonemetalproducts.com



ATTENTION: THE RUBY GRILL MUST BE INSTALLED ACCORDING TO THE INSTALLATION GUIDE SHOWN ON PAGES 9 THRU 14. IF YOUR GRILL INSTALLATION DOES NOT MEET THE BASIC SETUP INSTRUCTIONS ALL WARRANTIES MAY BE VOID. SEE WARRANTY ON LAST PAGE.

Welcome & Congratulations

Congratulations on your purchase of a new Ruby grill! We are very proud of our product and we are completely committed to providing you with the best service possible. Your satisfaction is our #1 priority. Please read this manual carefully to understand all the instructions about how to install, operate and maintain for optimum performance and longevity. We know you'll enjoy your new grill and thank you for choosing our product. We hope you consider us for future purchases.

How to Obtain Service

Before you call

Is there Gas supplied to the Grill?

Have you recently refilled the LP Tank?

Please make sure you have the following information:

MODEL NUMBER | DATE OF PURCHASE | INVOICE NUMBER.

KEEP A COPY OF THE GRILLS ITEMIZED INVOICE FOR YOUR RECORDS

For warranty service, contact SUNSTONE Customer Service Department at (888)-934-9449 or email service@sunstonemetalproducts.com.

SUNSTONE METAL PRODUCTS LLC.
16004 Central Commerce Dr, Pflugerville Texas 78660.

Business Hours.
Mon. to Thur. 9:00AM to 4:30PM
Closed Fri/Sat/Sun

Tel: 512-487-5116
Toll Free: 888-934-9449 (Technical Support Line)
Fax: 512-487-7016

Must keep copy of your sales slip for proof of purchase.

NAME _____ DATE OF PURCHASE _____

ADDRESS _____

MODEL NO _____ INVOICE NO _____

COMPANY THAT YOU PURCHASED FROM _____

INDEX DIRECTORY

SPECIFICATIONS

RUBY3B 30" GRILL -----	1-2
RUBY4B 36" GRILL -----	3-4
RUBY4BIR 36" GRILL W/IR ----	5-6
RUBY5BIR 42" GRILL W/IR ----	7-8

LOCATING THE GRILL

Grill Cut-Out Dimensions -----	9
Installing into Open Area -----	10
Installing into Windy Area -----	11
Installing under Structure -----	12
Installing into Enclosure -----	13-14

GRILL INSTALLATION

Light Transformer -----	15
Propane Tank Types -----	16-17
LP Gas Line Connections -----	18
NG Gas Line Connections -----	19
Propane Tank Connections ---	20-22

USING YOUR GRILL

Cooking Zones -----	23
Smoker/Steamer Box -----	24
Pro-Sear Burner -----	25
Burner Adjustments -----	26
Rotisserie Setup -----	27
Rotisserie Cooking -----	28
Lighting the Rotisserie -----	29

SAFETY CHECKS

Leak Test -----	30-31
Attention & Warnings -----	32

GRILL STARTUP

Grill Safety -----	33
Lighting the Grill -----	34

CARE & MAINTANCE

Cleaning the Grill -----	35
Opening the Panel -----	36-37

GAS CONVERSION

Cooking Zones -----	38-44
---------------------	-------

WARRANTY 45



ATTENTION: Indicates a potentially hazardous situation which, if not avoided, may result in minor or moderate personal injury, or property damage.

WARNING: Indicates an imminently hazardous situation which, if not avoided, will result in death or serious injury.

VOLTAGE: Indicates a potentially hazardous situation which, if not avoided, may result in minor or moderate electrical shock.

EXPLOSION: Indicates an imminently hazardous situation which, if not avoided, will result in possible explosion and cause death or serious injury.

BODILY INJURY: Indicates a potentially hazardous situation which, if not avoided, may result in minor or moderate personal injury, or property damage.

HOT SURFACE: Indicates an imminently hazardous hot surface which, if not avoided, will result in serious burn or injury.

LIVE CIRCUIT: Indicates a potentially hazard from Live electrical current that if extreme caution is not used, may result in minor or moderate personal injury, or property damage.

START-UP

CHECKLIST

Caution: Never operate the grill unattended.

FIRST TIME STARTUP CHECKLIST

- ☑ The burner is free of any debris or obstruction.
- ☑ Installation of the proper gas type and regulator settings.
- ☑ The proper gas connection is complete.
- ☑ Minimum clearances are maintained.
- ☑ All packaging has been removed.
- ☑ All parts and components are properly installed.
- ☑ An installer-supplied manual gas shut-off valve is fully accessible.
- ☑ LP hose is clean and inspected for cuts, wear, abrasion, or leaks. Replace if necessary, with a suitable UL, ETL or CSA Listed part with internally threaded connector.



WARNING: If you have a Side Yard Propane Tank, you MUST have additional Medium Pressure Regulator located at the Grill. If you do not serious bodily harm may result or damage to the grill and island structure from HIGH Heat extremes.

SPECIFICATIONS – Ruby 30” 3 Burner - Pro Sear Product Overview

Model Series	
RUBY3B-NG 30”	
RUBY3B-LP 30”	
All 304 Stainless Steel	
Product Overview	
Cooking Grid Size---	27-1/2" X 19-1/2"
Burger Count-----	28 burgers
Warming Rack-----	151.25 Sq. Inch
Main Cooking Space	536.25 Sq. Inch
Total Cooking Space	687.5 Sq. Inch
Grilling Surface BTU's & Heat	
Grill Surface BTU's---	45,000 Btu's
Pro Searing Grid ---	Max -700°F- Open Max - 800°F- Closed
Single Burner Heat--	Up-to 350°F -400°F
Product Specifications	
Product Net Weight	112
Hood Closed	
Overall Width-----	30"
Overall Height-----	22"
Overall Depth-----	27"
Control Panel Height	10-5/8"
Hood Open Size	
Counter to Top-----	25-1/2"
Overall Depth-----	30"
Hood Overhang-----	3"
Cut out Size	
Width-----	27-1/2"
Depth-----	22"
Height-----	10"
Components	
Rotisserie Assembly	Optional
Pro Searing Grid	Included
IR Sear Burner	Optional
Smoker Box	Optional
BBQ Grill Cover	Optional

HOOD CLOSED - FRONT VIEW

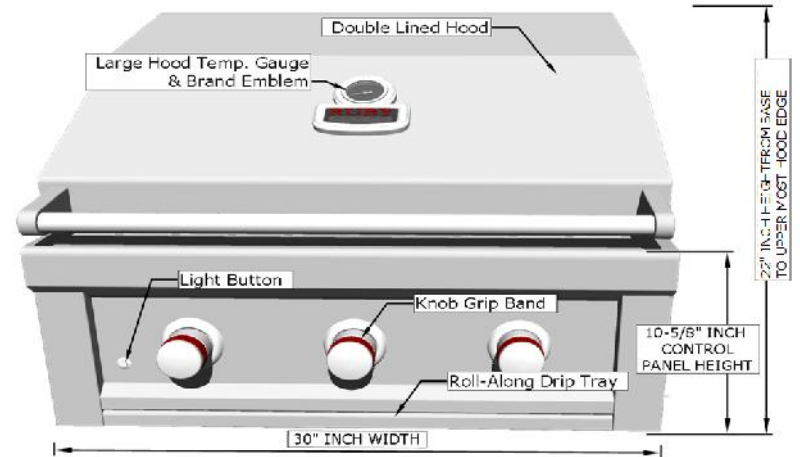

HOOD CLOSED - BACK VIEW

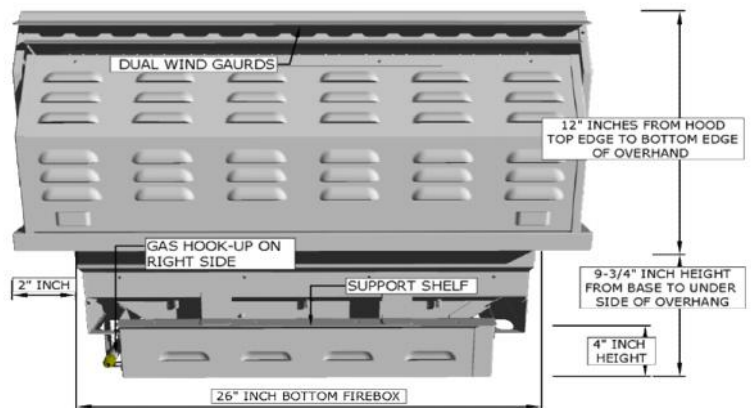

HOOD OPEN - RIGHT SIDE VIEW

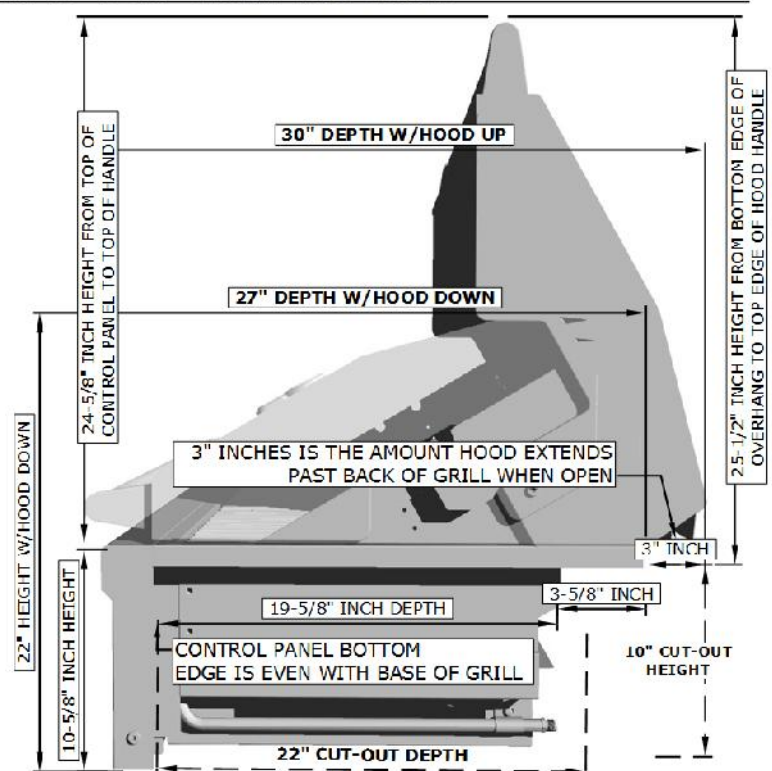

SPECIFICATIONS – Parts Diagram/Ruby3B 30”

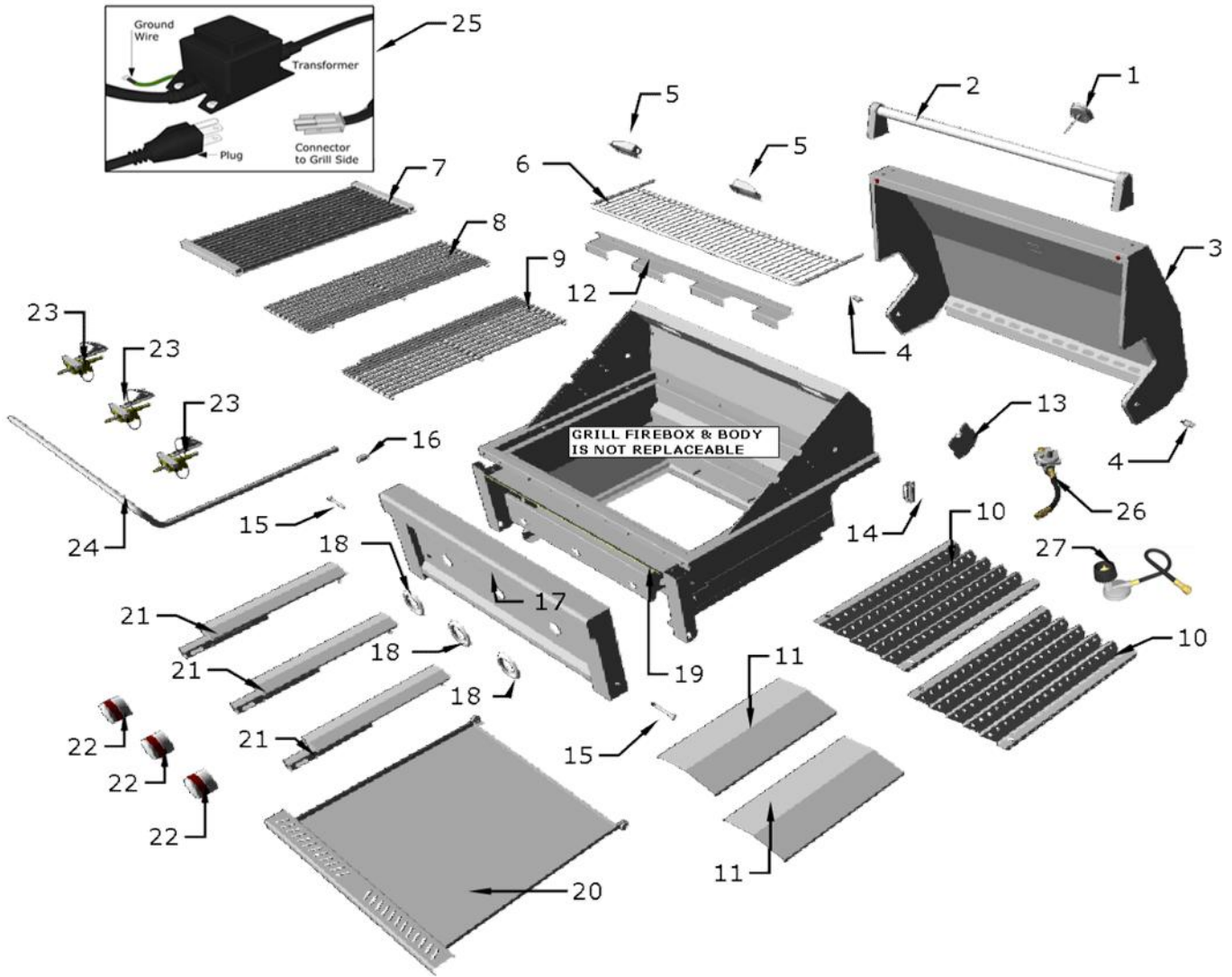

RUBY3B-LP / RUBY3B-NG Parts List			
No.	Description	Q	Part No.
1	Thermostat	1	R-TMETER
2	Hood Handle	1	Hood-R3B-H
3	Hood	1	Hood-R3B
4	Hood Bolt	2	R-HAB
5	Light Assembly	2	R-LIGHT
6	Warming Rack	1	R-WR-3B
7	Pro Searing Grate	1	R-GSEAR3B
8	Grate	1	R-GR3B
9	Grate	1	R-GR3B
10	Warming grid	2	R-FL-3B
11	Heat Shield	2	R-HS-3B
12	Gas Transfer	1	R-GSC-3B
13	Rot. Mount	1	R-RMOUNT
14	Manifold Clip	1	R-MFCLIP
15	Panel Bolt	2	R-PANBOLT
16	Light Switch	1	R-LIGHT-SW
17	Control Panel	1	R-PANEL-3B
18	Knob Ring	3	P-KNOB-R
19	LED Light	1	R-LED-3B
20	Drip Pan	1	R-DTRAY-3B
21	"I" Burner	3	P-GBURNER
22	Knob	3	P-KNOB-L
23	Valve – LP/NG	3	R-VALVE
24	Manifold Pipe	1	R-GMP-3B
25	Transformer Plug	1	P-LPB
26	Regulator - NG	1	NGH18
27	Regulator - LP	1	LP-REG

RUBY3B-LP / RUBY3B-NG Parts List			
No.	Description	Q	Part No.
15	Panel Bolt	2	R-PANBOLT
16	Light Switch	1	R-LIGHT-SW
17	Control Panel	1	R-PANEL-3B
18	Knob Ring	3	P-KNOB-R
19	LED Light	1	R-LED-3B
20	Drip Pan	1	R-DTRAY-3B
21	"I" Burner	3	P-GBURNER
22	Knob	3	P-KNOB-L
23	Valve – LP/NG	3	R-VALVE
24	Manifold Pipe	1	R-GMP-3B
25	Transformer Plug	1	P-LPB
26	Regulator - NG	1	NGH18
27	Regulator - LP	1	LP-REG

SPECIFICATIONS – Ruby 36” 4 Burner - Pro Sear Product Overview

Model Series	
RUBY4B-NG 36”	
RUBY4B-LP 36”	
All 304 Stainless Steel	
Product Overview	
Cooking Grid Size---	33-1/2" X 19-1/2"
Burger Count-----	32 burgers
Warming Rack-----	184.25 Sq. Inch
Main Cooking Space	653.25 Sq. Inch
Total Cooking Space	837.5 Sq. Inch
Grilling Surface BTU's & Heat	
Grill Surface BTU's---	60,000 Btu's
Pro Searing Grid ---	Max -700°F- Open Max - 800°F- Closed
Single Burner Heat--	Up-to 350°F -400°F
Product Specifications	
Product Net Weight	134
Hood Closed	
Overall Width-----	36"
Overall Height-----	22"
Overall Depth-----	27"
Control Panel Height	10-5/8"
Hood Open Size	
Counter to Top-----	25-1/2"
Overall Depth-----	30"
Hood Overhang-----	3"
Cut out Size	
Width-----	33-1/2"
Depth-----	22"
Height-----	10"
Components	
Rotisserie Assembly	Optional
Pro Searing Grid	Included
IR Sear Burner	Optional
Smoker Box	Optional
BBQ Grill Cover	Optional

HOOD CLOSED - FRONT VIEW

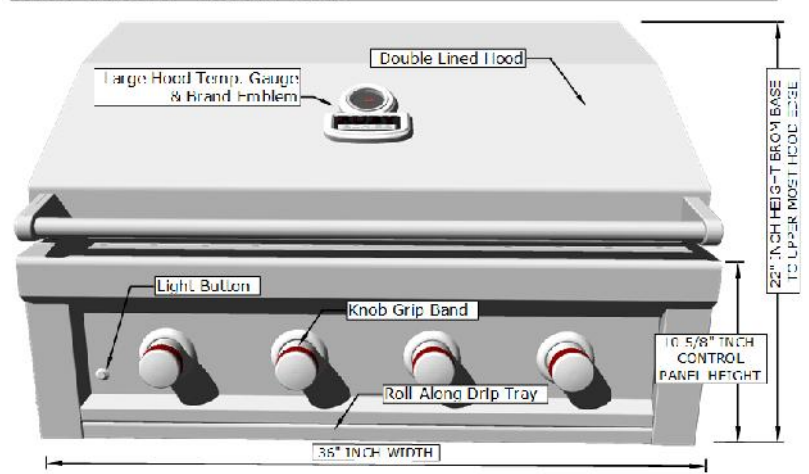

HOOD CLOSED - BACK VIEW

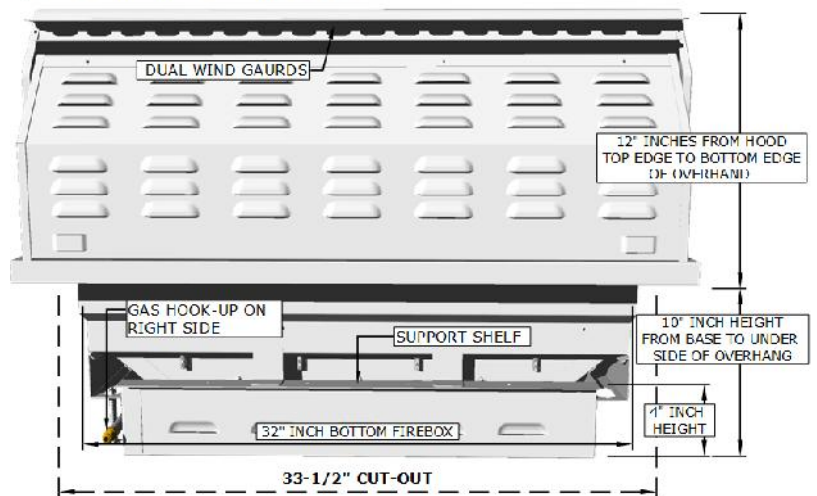

HOOD OPEN - RIGHT SIDE VIEW

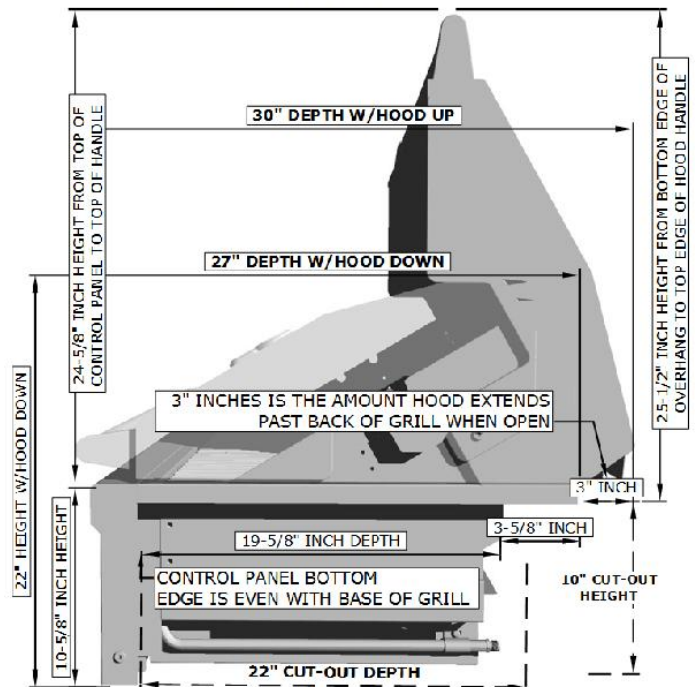

SPECIFICATIONS – Parts Diagram/Ruby4B 36”

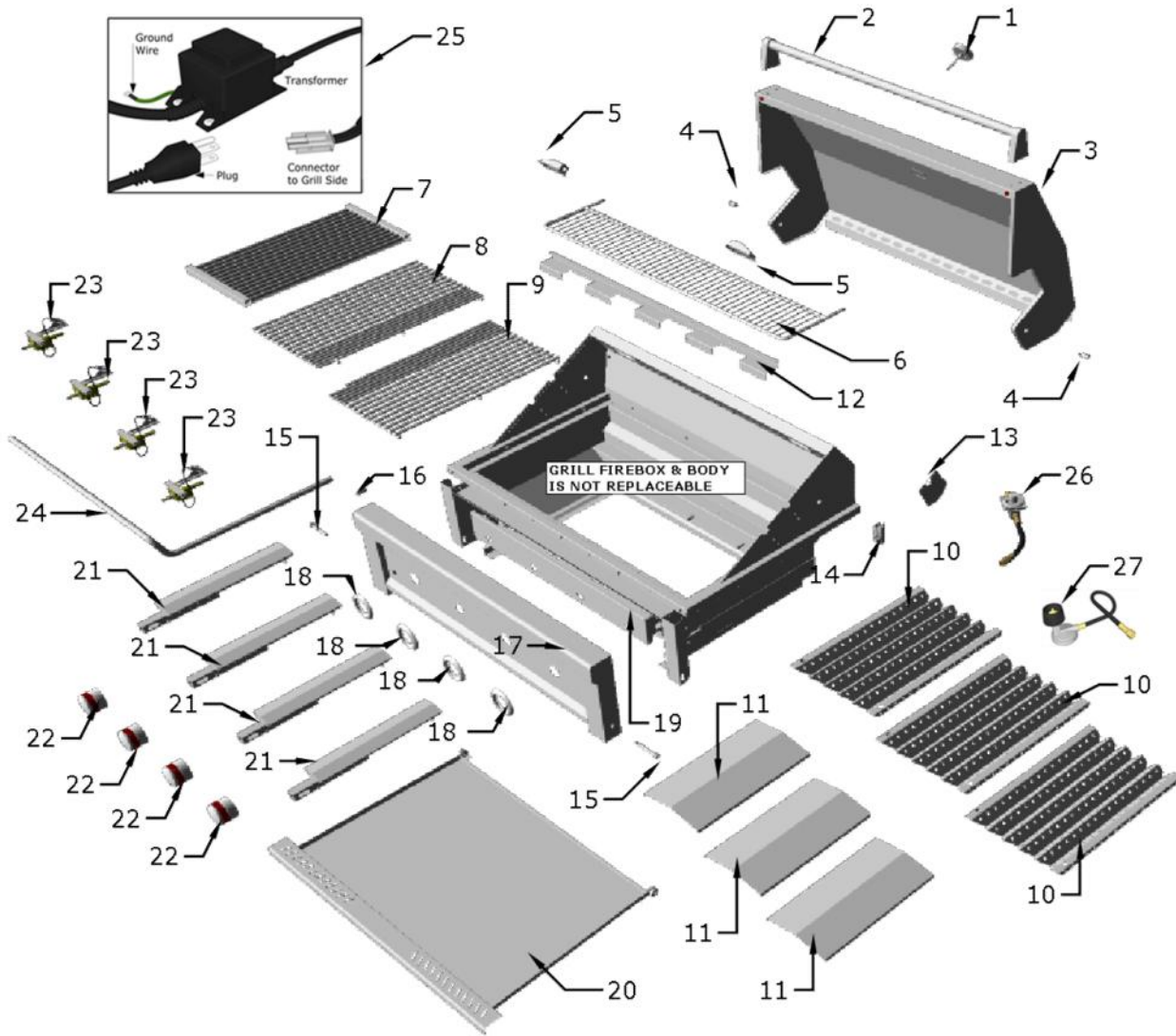

RUBY4B-LP / RUBY4B-NG Parts List			
No.	Description	Q	Part No.
1	Thermostat	1	R-TMETER
2	Hood Handle	1	Hood-R4B-H
3	Hood	1	Hood-R4B
4	Hood Bolt	2	R-HAB
5	Light Assembly	2	R-LIGHT
6	Warming Rack	1	R-WR-4B
7	Pro Searing Grate	1	R-GSEAR
8	Grate	1	R-GR4B
9	Grate	1	R-GR4B
10	Warming grid	3	R-FL-4B
11	Heat Shield	3	R-HS-4B
12	Gas Transfer	1	R-GSC-4B
13	Rot. Mount	1	R-RMOUNT
14	Manifold Clip	1	R-MFCLIP

RUBY4B-LP / RUBY4B-NG Parts List			
No.	Description	Q	Part No.
15	Panel Bolt	2	R-PANBOLT
16	Light Switch	1	R-LIGHT-SW
17	Control Panel	1	R-PANEL-4B
18	Knob Ring	4	P-KNOB-R
19	LED Light	1	R-LED-4B
20	Drip Pan	1	R-DTRAY-4B
21	"I" Burner	4	P-GBURNER
22	Knob	4	P-KNOB-L
23	Valve – LP/NG	4	R-VALVE
24	Manifold Pipe	1	R-GMP-4B
25	Transformer Plug	1	P-LPB
26	Regulator - NG	1	NGH18
27	Regulator - LP	1	LP-REG

SPECIFICATIONS – Ruby 36” 4 Burner IR - Pro Sear Product Overview

Model Series	
RUBY4BIR-NG 36”	
RUBY4BIR-LP 36”	
All 304 Stainless Steel	
Product Overview	
Cooking Grid Size---	33-1/2" X 19-1/2"
Burger Count-----	32 burgers
Warming Rack-----	184.25 Sq. Inch
Main Cooking Space	653.25 Sq. Inch
Total Cooking Space	837.5 Sq. Inch
Grilling Surface BTU's & Heat	
Grill Surface BTU's---	60,000 Btu's
Rot. Burner BTU's ---	15,000 Btu's
Pro Searing Grid ---	Max -700°F- Open Max - 800°F- Closed
Single Burner Heat--	Up-to 350°F -400°F
IR Burner Heat -----	Up-to 1200°F
Product Specifications	
Product Net Weight	144
Hood Closed	
Overall Width-----	36"
Overall Height-----	22"
Overall Depth-----	27"
Control Panel Height	10-5/8"
Hood Open Size	
Counter to Top-----	25-1/2"
Overall Depth-----	30"
Hood Overhang-----	3"
Cut out Size	
Width-----	33-1/2"
Depth-----	22"
Height-----	10"
Components	
Rotisserie Assembly	Included
Pro Searing Grid	Included
IR Sear Burner	Optional
Smoker Box	Optional
BBQ Grill Cover	Optional

HOOD CLOSED - FRONT VIEW

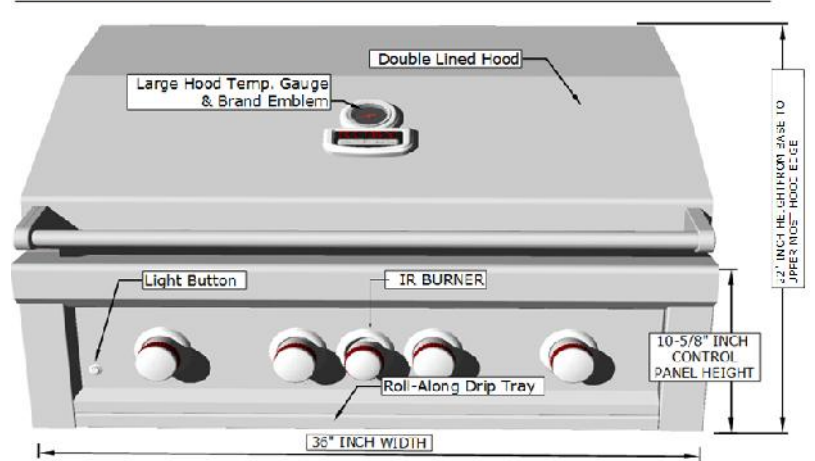

HOOD CLOSED - BACK VIEW

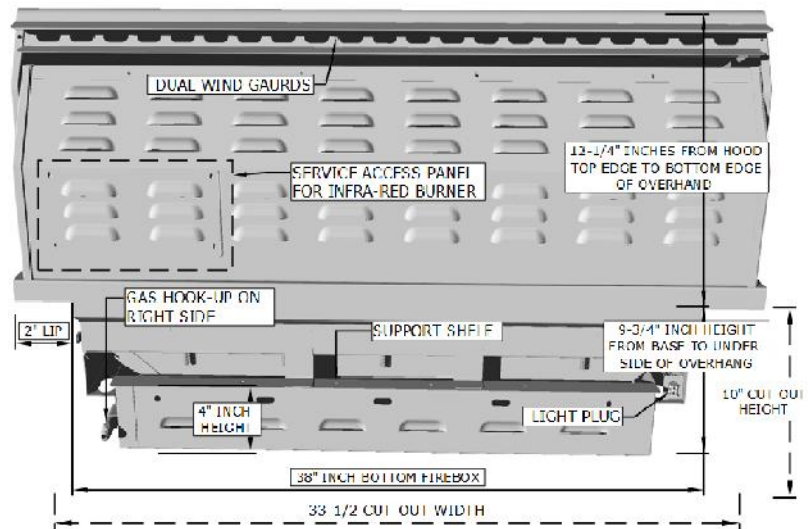

HOOD OPEN - RIGHT SIDE VIEW

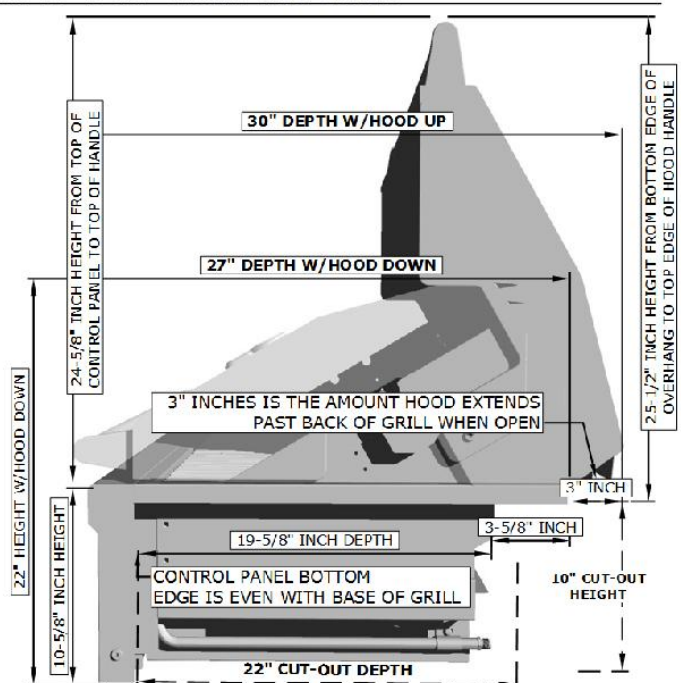

SPECIFICATIONS – Parts Diagram/Ruby4BIR 36”

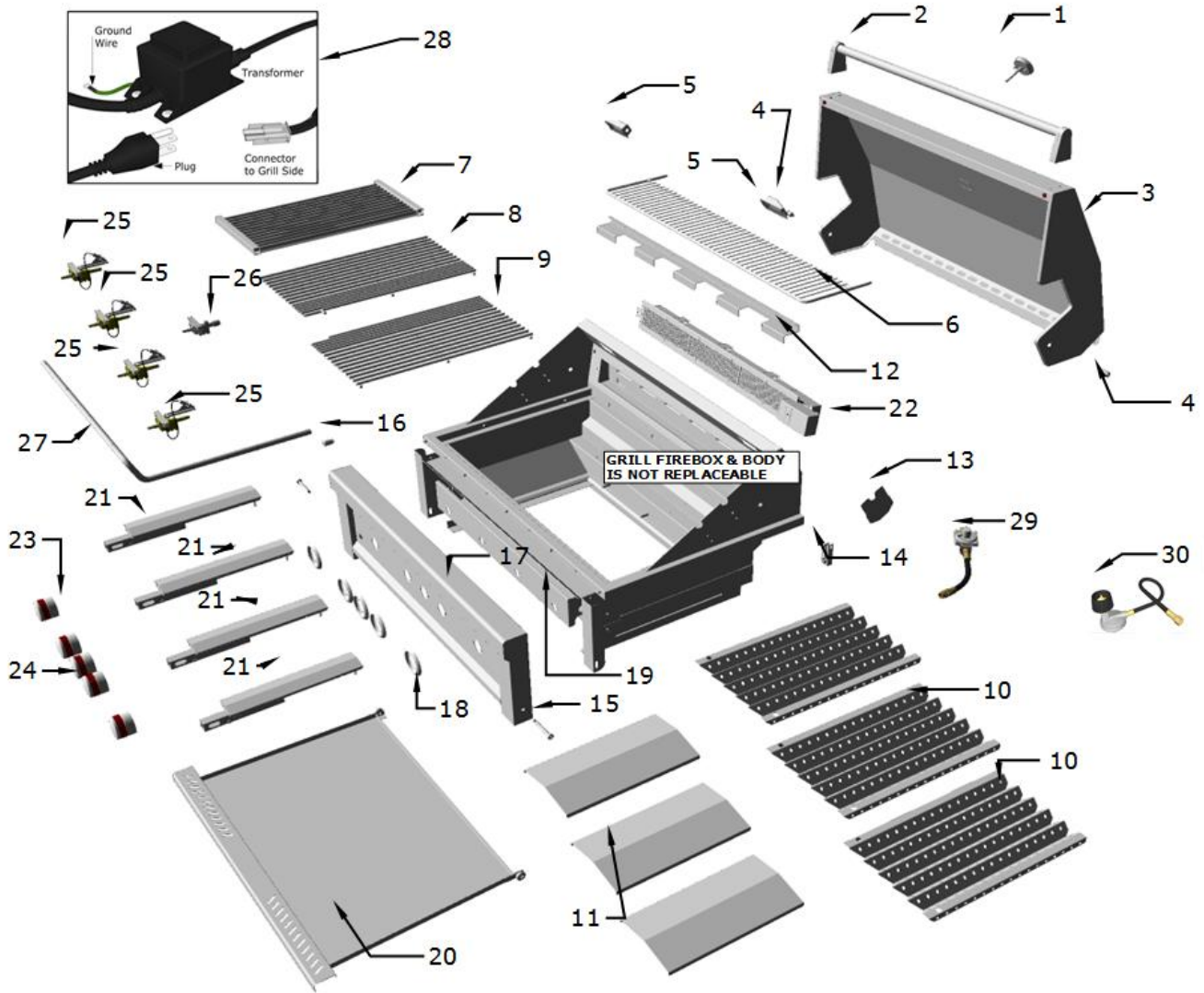

RUBY4BIR-LP / RUBY4BIR-NG Parts			
No.	Description	Q	Part No.
1	Thermostat	1	R-TMETER
2	Hood Handle	1	Hood-R4B-H
3	Hood	1	Hood-R4B
4	Hood Bolt	2	R-HAB
5	Light Assembly	2	R-LIGHT
6	Warming Rack	1	R-WR-4B
7	Pro Searing Grate	1	R-GSEAR4B
8	Left Grate	1	R-GR4BL
9	Right Grate	1	R-GR4BR
10	Warming grid	3	R-FL-4B
11	Heat Shield	3	R-HS-4B
12	Gas Transfer	1	R-GSC-4B
13	Rot. Mount	1	R-RMOUNT
14	Manifold Clip	1	R-MFCLIP
15	Panel Bolt	2	R-PANBOLT

RUBY4BIR-LP / RUBY4BIR-NG Parts			
No.	Description	Q	Part No.
16	Light Switch	1	R-LIGHT-SW
17	Control Panel	1	R-PANEL-4B
18	Knob Ring	5	P-KNOB-R
19	LED Light	1	R-LED-4B
20	Drip Pan	1	R-DTRAY-4B
21	"I" Burner	4	P-GBURN
22	Infra-Red Burner	1	R-IRBURN-4BIR
23	Large Knob	4	P-KNOB-L
24	Small Knob	1	P-KNOB-S
25	Ignition Valve	4	R-VALVE LP/NG
26	IR-Ignition Valve	1	R-IRVALVE
27	Manifold Pipe	1	R-GMP-4BIR
28	Transformer Plug	1	P-LPB
29	Regulator - NG	1	NGH18
30	Regulator - LP	1	LP-REG

SPECIFICATIONS – Ruby 42” 5 Burner IR - Pro Sear Product Overview

Model Series	
RUBY5BIR-NG 42”	
RUBY5BIR-LP 42”	
All 304 Stainless Steel	
Product Overview	
Cooking Grid Size---	39-1/2" X 19-1/2"
Burger Count-----	36 burgers
Warming Rack-----	217.25 Sq. Inch
Main Cooking Space	770.25 Sq. Inch
Total Cooking Space	987.5 Sq. Inch
Grilling Surface BTU's & Heat	
Grill Surface BTU's---	75,000 Btu's
Rot. Burner BTU's ---	15,000 Btu's
Pro Searing Grid ---	Max -700°F- Open Max - 800°F- Closed
Single Burner Heat--	Up-to 350°F -400°F
IR Burner Heat -----	Up-to 1200°F
Product Specifications	
Product Net Weight	172
Hood Closed	
Overall Width-----	42"
Overall Height-----	22"
Overall Depth-----	27"
Control Panel Height	10-5/8"
Hood Open Size	
Counter to Top-----	25-1/2"
Overall Depth-----	30"
Hood Overhang-----	3"
Cut out Size	
Width-----	39-1/2"
Depth-----	22"
Height-----	10"
Components	
Rotisserie Assembly	Included
Pro Searing Grid	Included
IR Sear Burner	Optional
Smoker Box	Optional
BBQ Grill Cover	Optional

HOOD CLOSED - FRONT VIEW

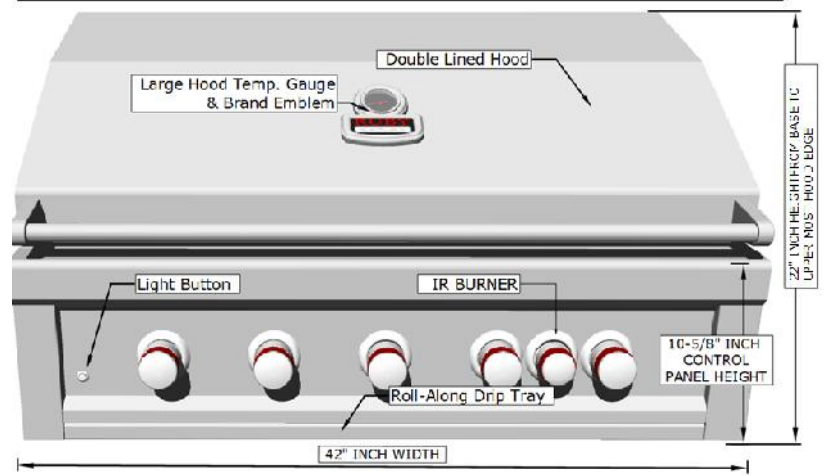

HOOD CLOSED - BACK VIEW

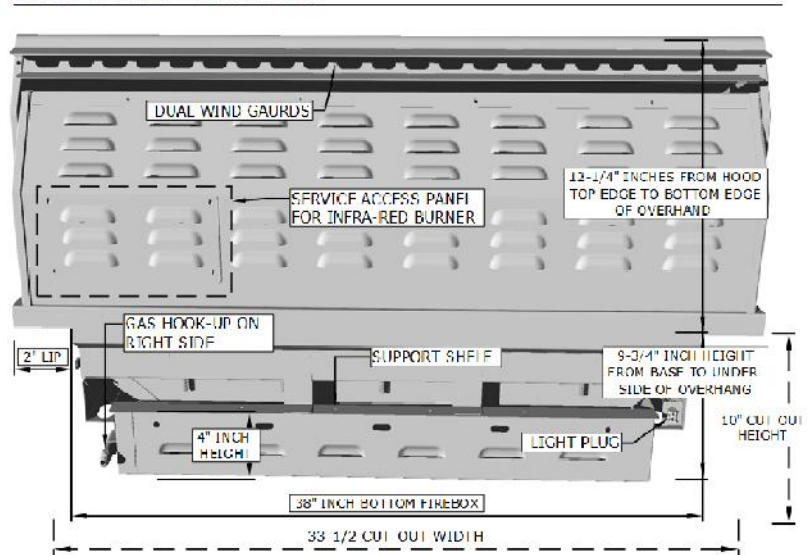

HOOD OPEN - RIGHT SIDE VIEW

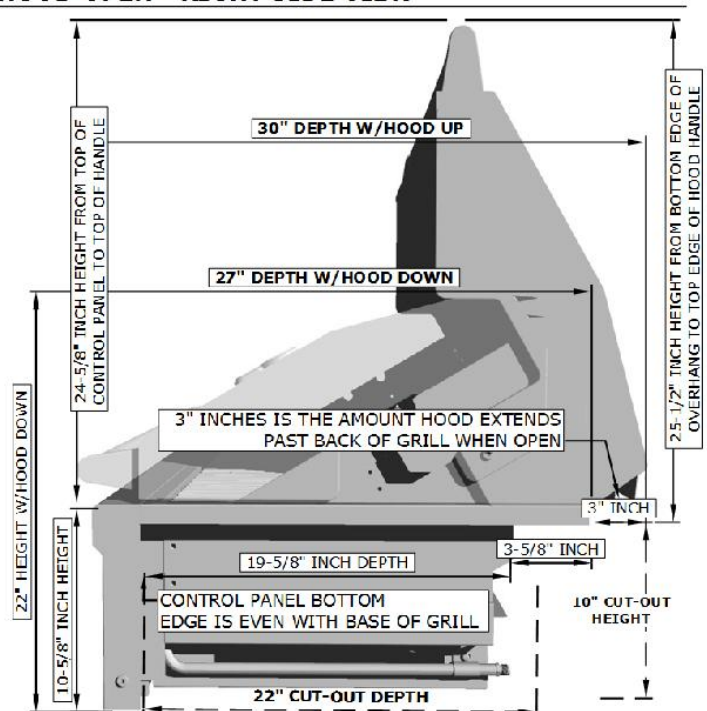

SPECIFICATIONS – Parts Diagram/Ruby5BIR 42”

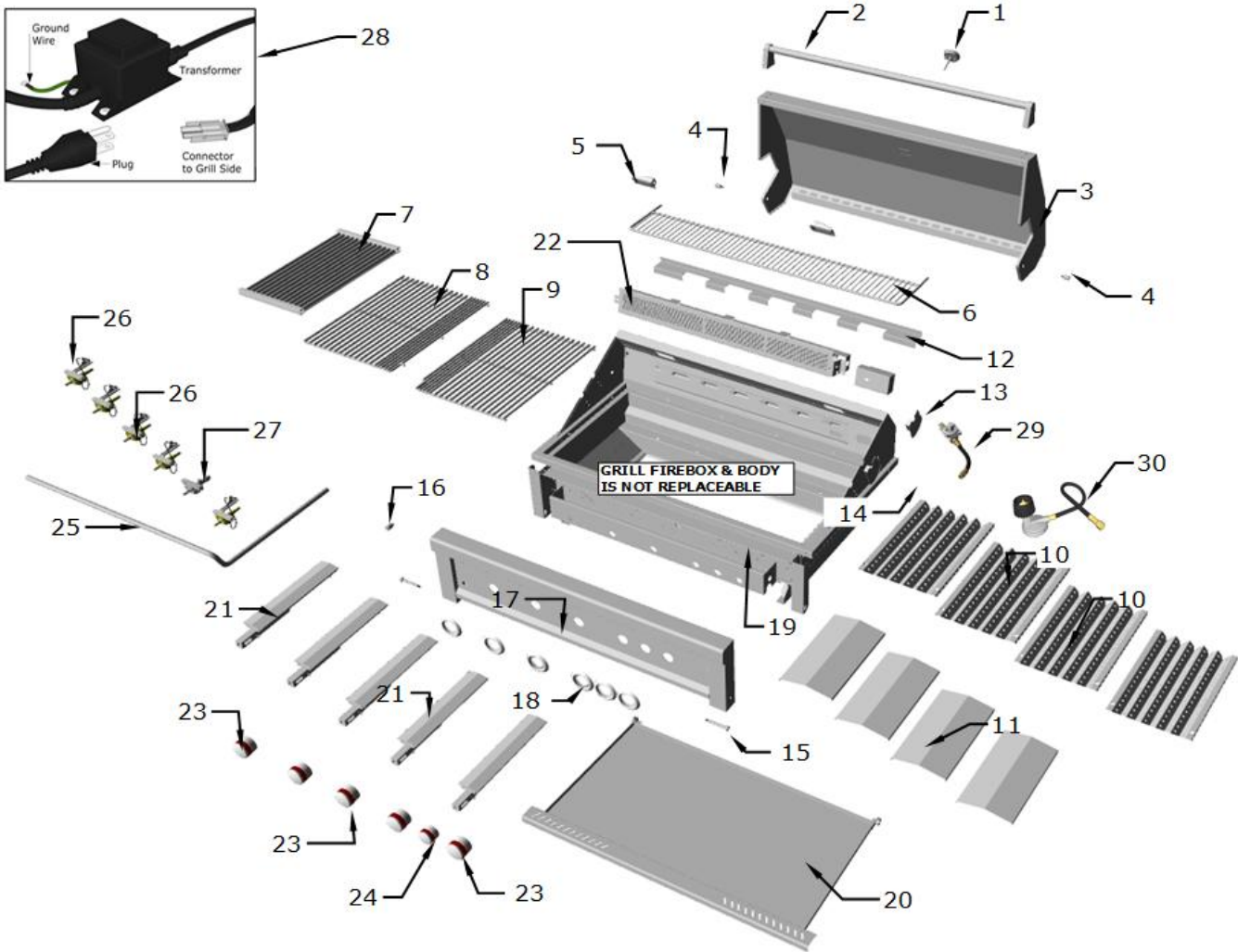

RUBY5BIR-LP / RUBY5BIR-NG Parts			
No.	Description	Q	Part No.
1	Thermostat	1	R-TMETER
2	Hood Handle	1	Hood-R5B-H
3	Hood	1	Hood-R5B
4	Hood Bolt	2	R-HAB
5	Light Assembly	2	R-LIGHT
6	Warming Rack	1	R-WR-5B
7	Pro Searing Grate	1	R-GSEAR5B
8	Left Grate	1	R-GR5BL
9	Right Grate	1	R-GR5BR
10	Warming grid	4	R-FL-5B
11	Heat Shield	4	R-HS-5B
12	Gas Transfer	1	R-GSC-5B
13	Rot. Mount	1	R-RMOUNT
14	Manifold Clip	1	R-MFCLIP
15	Panel Bolt	2	R-PANBOLT

RUBY5BIR-LP / RUBY5BIR-NG Parts			
No.	Description	Q	Part No.
16	Light Switch	1	R-LIGHT-SW
17	Control Panel	1	R-PANEL-5B
18	Knob Ring	6	P-KNOB-R
19	LED Light	1	R-LED-5B
20	Drip Pan	1	R-DTRAY-5B
21	"I" Burner	5	P-GBURN
22	Infra-Red Burner	1	R-IRBURN-5BIR
23	Large Knob	5	P-KNOB-L
24	Small Knob	1	P-KNOB-S
25	Manifold Pipe	1	R-GMP-5B
26	Ignition Valve	5	R-VALVE LP/NG
27	IR-Ignition Valve	1	R-IRVALVE
28	Transformer Plug	1	P-LPB
29	Regulator - NG	1	NGH18
30	Regulator - LP	1	LP-REG

LOCATING GRILL – Grill Cut-Out Dimensions

Grill Cut-Out

Your grill is SELF-RIMMING, meaning the lip of grill rests on top of the counter edge around the cut-out with the front of grill which is Free-Hanging from counter top. Because of this, there is No Need for any Trim-Kit like with many other grills in the market.

1. Maintain 24" Clearance from any Combustible Materials in ANY direction of Grill.
2. If any combustible materials within 24" distance, must have Heat Barrier like Grill Jacket, or other Non-Combustible type like Bricks, Hardy Board, Metal.
3. Orient the grill so the Prevailing winds are not blowing into the rear or side of grill.



WARNING: Never build shelf or enclose interior space under the BBQ Cut-Out. The Ruby Grill is Self-Rimming and is supported by the top counter surface on the Back and Sides, the front of grill is designed to Free-Hang. The bottom of Grill needs to be open to allow for proper ventilation.

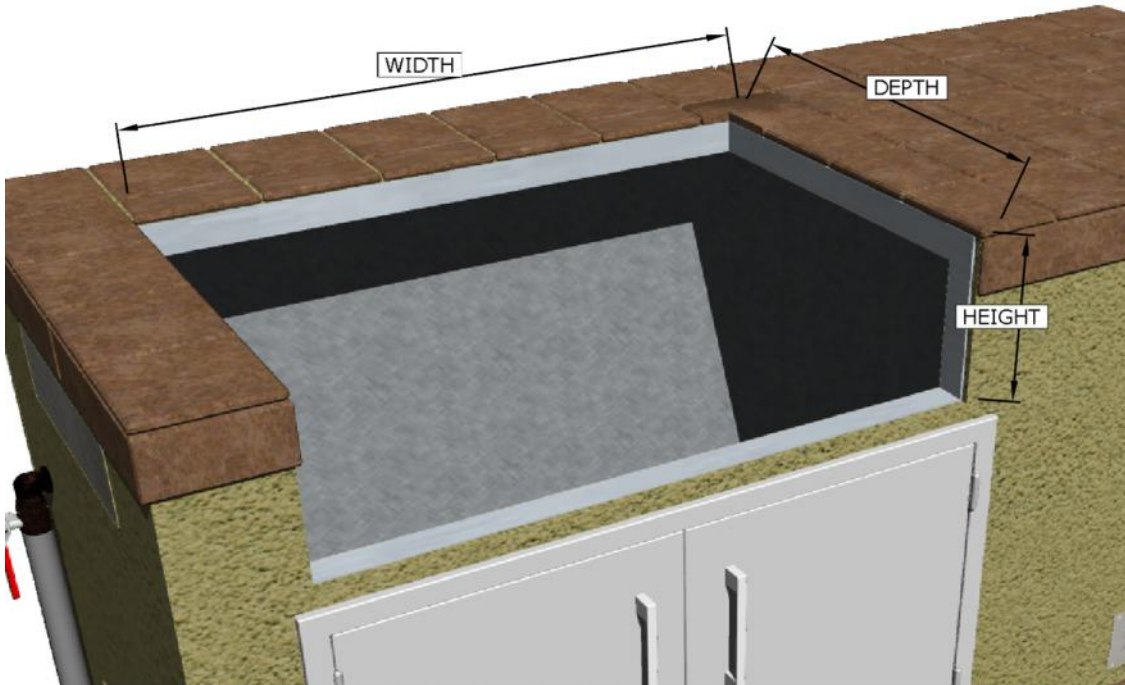

Ruby Series Grill Island Cut-Out Dimensions

ITEM NO.	WIDTH	DEPTH	HEIGHT
RUBY3B – LP/NG	27-1/2" Inch	22" Inch	10" Inch
RUBY4B – LP/NG	33-1/2" Inch	22" Inch	10" Inch
RUBY4BIR – LP/NG	33-1/2" Inch	22" Inch	10" Inch
RUBY5BIR – LP/NG	39-1/2" Inch	22" Inch	10" Inch

LOCATING GRILL – Installing into Open Area

Windy Conditions

Your grill is specially designed to draw fresh air in through the front, and in direct to the bottom burners. When grilling the hot gases are then released through the back of grill through a venting system. Using your grill in windy conditions may disrupt the front-to-back air flow.

1. For breezy days, be careful not to leave the front hood down for more than 15 minutes, when the burners are on. (**Never leave grill unattended when in operation**)
2. If you suspect the grill is overheating, using an oven mitt, open the front hood. Then adjust the burner control knob to off position.
3. Orient the grill so the Prevailing winds are not blowing into the rear or side of grill.

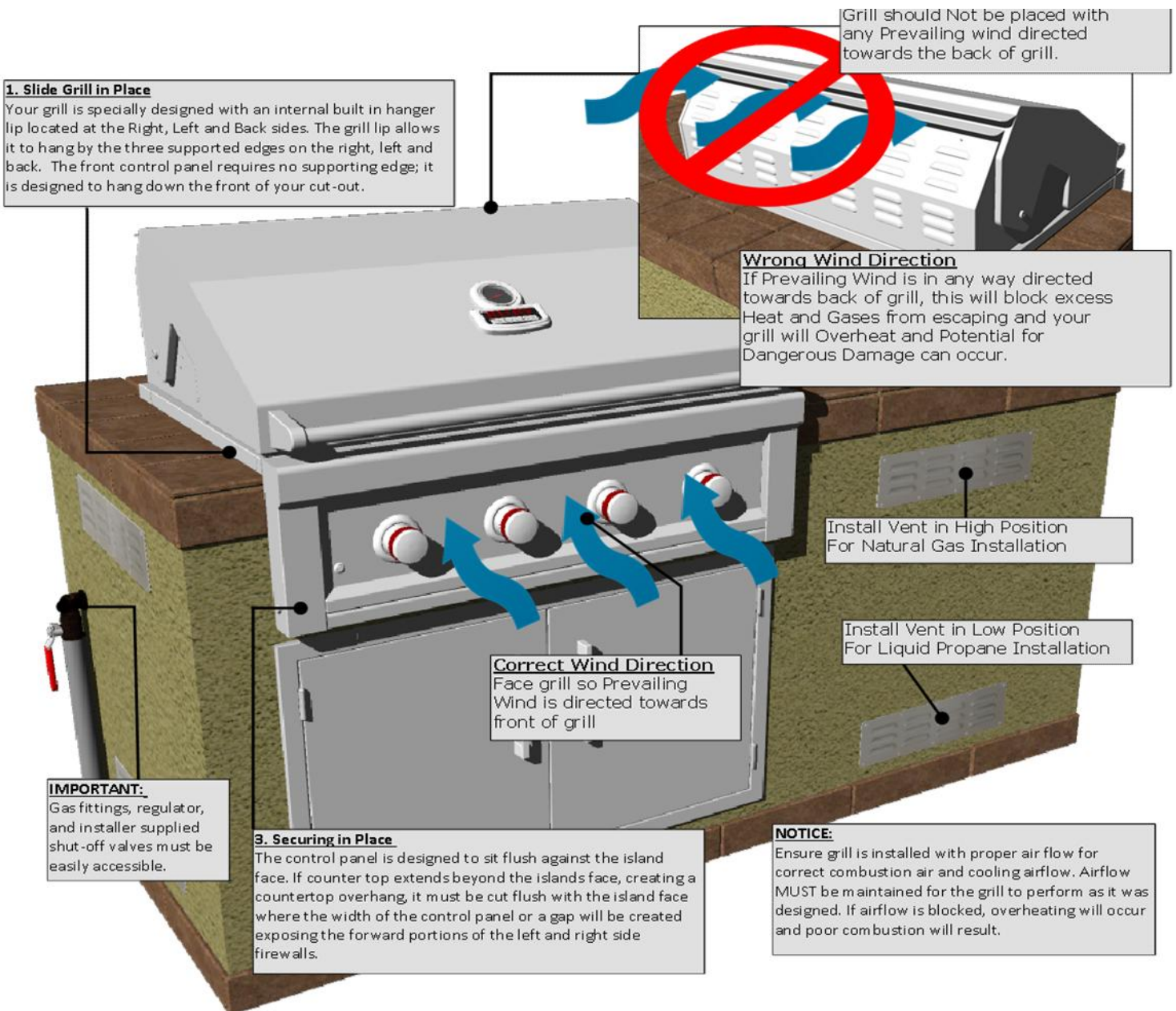

LOCATING GRILL– Installing into Windy Open Area

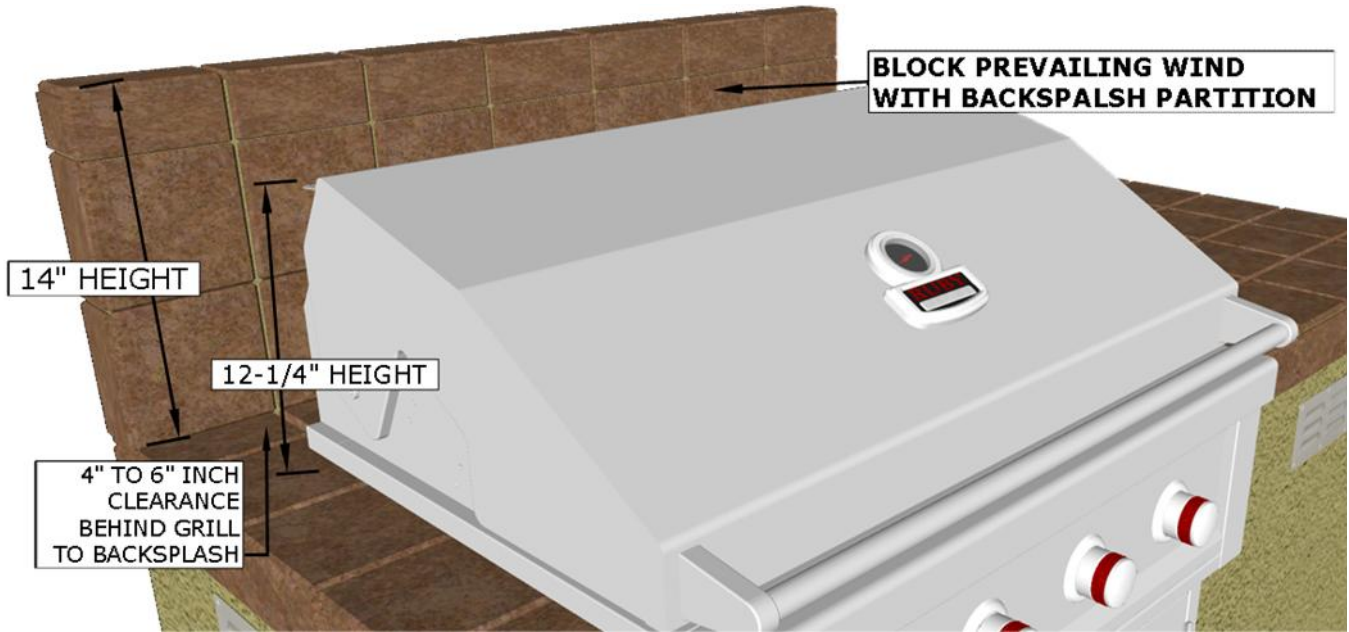

ATTENTION: Take special precaution when installing grill in open Breezy area, check the direction of Prevailing Wind, if back of grill is facing any oncoming wind or breeze, be sure to protect the back of grill, and erect a partition wall, or only use grill with hood open on breezy days.

Windy Area

Positioning your grill in your backyard is more often thought of how it is pleasing to the eye, but more important than this is how that it functions correctly. Unlike an indoor appliance, your grill must combat many outside weather influences in an all manner of weather-related instances, most severely is Wind.

1. Maintain proper Prevailing wind, grill direction – with the front of grill facing in to the wind, and the back of grill in the direct wind is blowing.
2. If direction of wind is unclear, or difficult to combat even with preventative measures, then always grill with the hood open, and when hood is closed – always be within proximity to grill and monitor it that it does not overheat.
3. If wind or breeze is in the direction of back of grill, you must erect partition wall of 14" height so that the top of grill hood is covered by several inches. If this is not done, you must grill with hood open and or when hood is closed stand in close area to grill and monitor if the grill overheats.



WARNING: NEVER BUILD YOUR OUTDOOR KITCHEN ISLAND USING COMBUSTIBLE MATERIALS, MAINTANE 24" DISTANCES FROM GRILL. USING A GRILL JACKET IS NOT A SURE BET TO PROTECT COMBUSTIBLE MATERIALS, NEITHER IS THE USE OF HARDY-BOARD.

LOCATING GRILL– Installing under overhead structure

Overhead Structure Definition:

Structure built above Appliance that is sometimes attached to the home's exterior outside wall or roof and there is a Minimum of "Two" adjacent sides which are open with outside exposure.

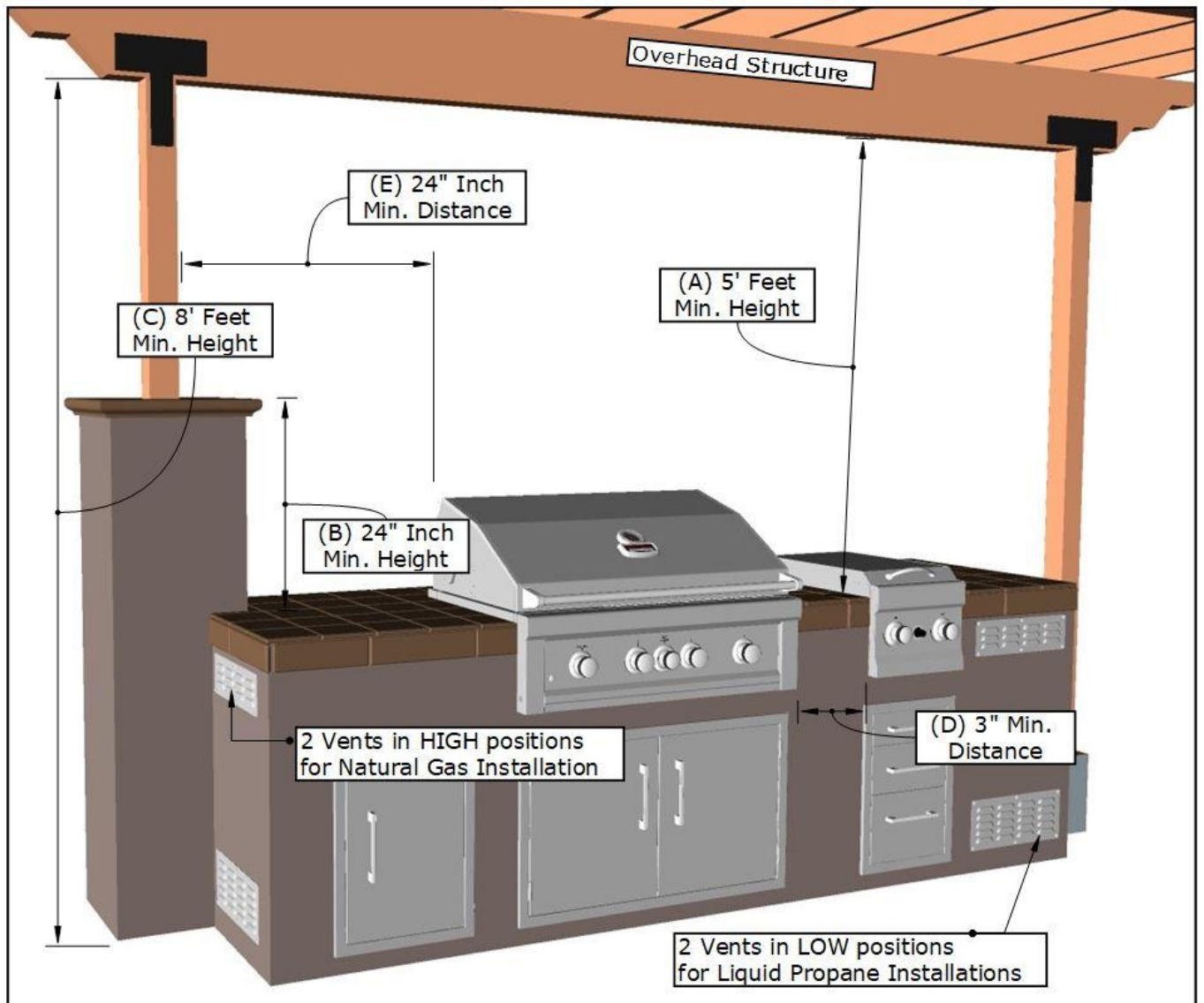

Minimum Distances to Combustible Materials or other Appliance ONLY, Non-Combustible materials do not apply!

(A) From Counter to Overhead Structure	5' Feet Min. Clearance
(B) From Counter to Combustible Material "if" within 24" distance	24" Min. Clearance
(C) From Floor to Underside of Overhead Structure	8' Feet Min. Clearance
(D) From Appliance to Appliance	3" Min. Clearance
(E) From Appliance to Combustible Material	24" Min. Clearance

LOCATING GRILL – Installing into Enclosed Area

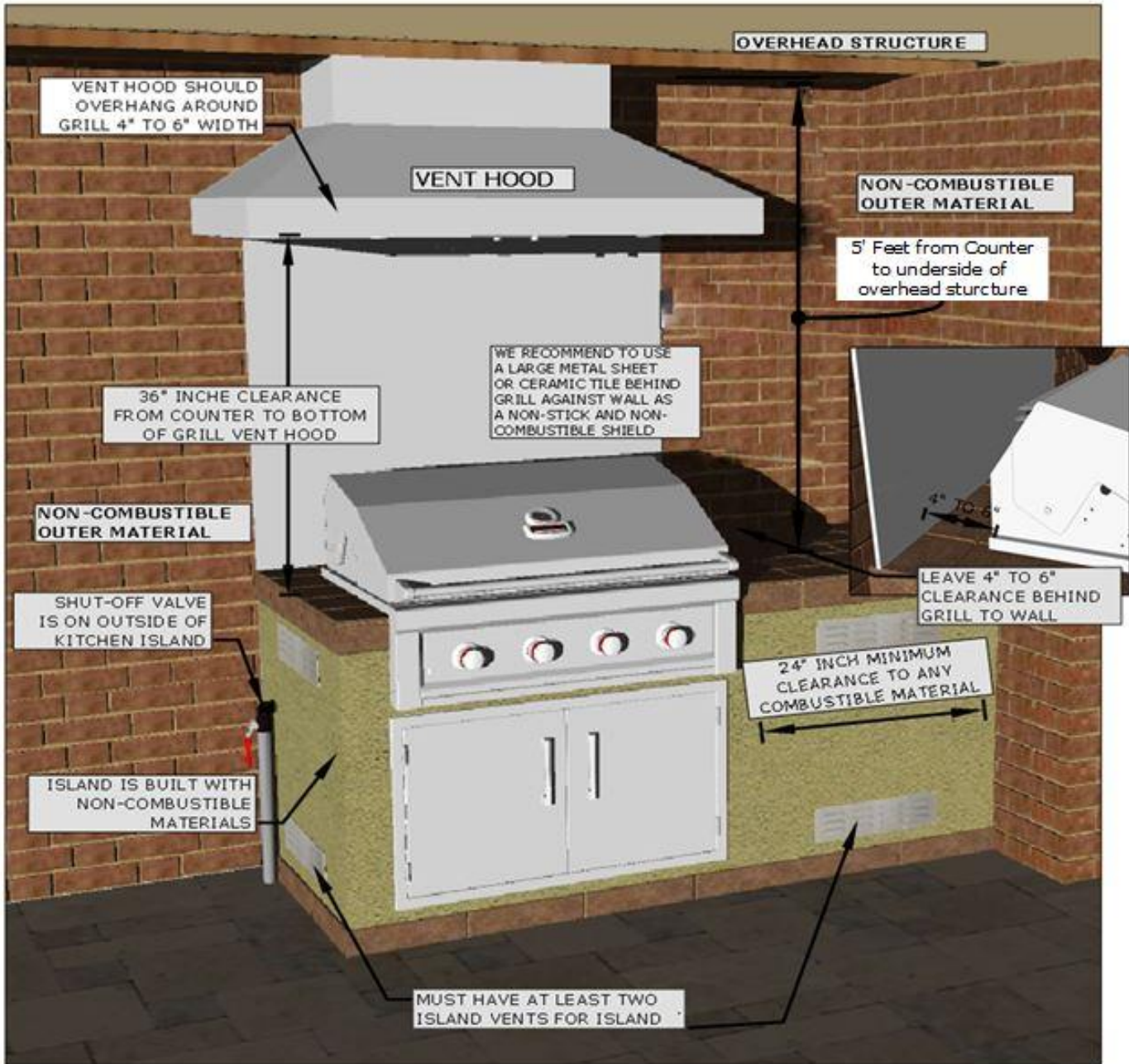

Minimum Distances to Combustible Materials or other Appliance ONLY, Non-Combustible materials do not apply!

From Counter to Overhead Structure	5' Feet Min. Clearance
From Counter to Outdoor Vent Hood	36" Min. Clearance
From Floor to Underside of Overhead Structure	8' Feet Min. Clearance
From Grill to Vent Hood Width	4"-6" Min. Clearance
From Appliance to Appliance	3" Min. Clearance
From Appliance to Combustible Material	24" Min. Clearance

LOCATING GRILL – Installing into Enclosed Area

Enclosed Island Definition:

Any Appliance that is installed into “Enclosed” structure with Two or more sides walled off, either into an outdoor home’s patio structure, against any home exterior wall or under any Eaves of the home.

Clearances to Non-Combustible Construction*:

A minimum of 4” to 6” clearance from the back of the grill to non-combustible construction is required for the purpose of allowing the lid to open fully. It is desirable to allow at least 6” rear and side clearance to construction above the cooking surface for counter space. If you’ll be using the rotisserie option, the space is essential for motor and skewer clearance.



ATTENTION: All Gas Grill Installations MUST HAVE MINIMUM TWO AIR-FLOW VENTS, either in ELEVATED POSITION for Natural Gas or LOWERED POSITION for Liquid Propane. Your Warranty may be VOID if island does not meet basic setup requirements.



BODILY INJURY: Failure to maintain required clearances creates a fire hazard that may result in property damage or serious personal injury.

Clearances to Combustible Construction:**

Minimum of 24” from the sides and rear of grill must be maintained to adjacent vertical combustible construction, above the counter top level. You should take in account that there is a large volume of heat, and smoke will exhaust from the rear of the grill. This may discolor or damage unprotected areas, do not install under unprotected combustible construction without using a fire safe ventilation system.

A 24” minimum clearance must be maintained under the counter top to combustible construction. The clearance can be modified by a use of an insulated jacket.

**** DEFINITION OF COMBUSTIBLE MATERIAL** - Any materials of a building structure or decorative structure made of wood, compressed paper, plant fibers, vinyl/plastic or other materials that are capable of transferring heat or being ignited and burned. Such material shall be considered combustible even though flame-proofed, fire-retardant treated or surface-painted, or plastered.



WARNING: NEVER BUILD YOUR OUTDOOR KITCHEN ISLAND USING COMBUSTIBLE MATERIALS, MAINTANE 24” DISTANCES FROM GRILL. USING A GRILL JACKET IS NOT A SURE BET TO PROTECT COMBUSTIBLE MATERIALS, NEITHER IS THE USE OF HARDY-BOARD.

GRILL INSTALLATION- Light Transformer Installation

1. Locate the transformer

Remove the transformer from the plastic bag located in the interior of grill. Make sure the Transformer is complete, and double check the grill light plug cord is properly secured to transformer, and all wires are firmly fixed into plastic clip plug.

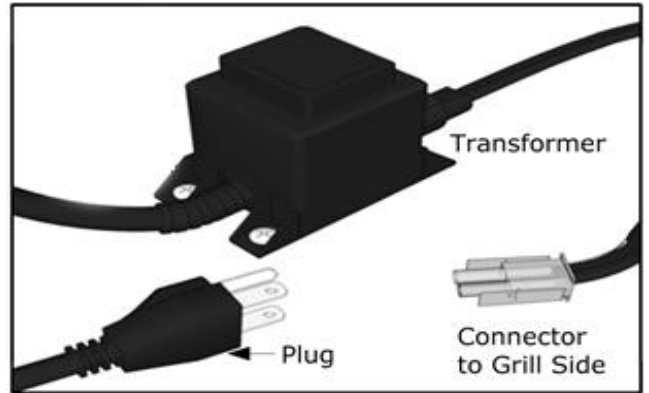

2. Mount Transformer

Using metal screws and attach the transformer to the back inner wall of your islands cabinet wall, somewhere near the already installed GFCI electrical outlet. When you plug the transformer in, double check then GFCI breaker switch, that the outlet has power.

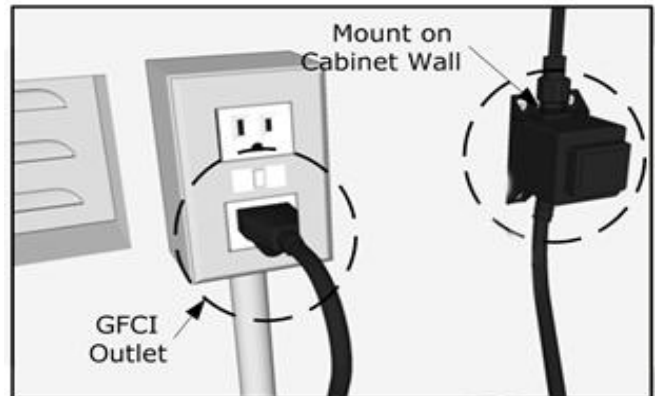

3. Make Connections

Locate the Light Switch on Left side BACK of grill. The connection clips together, to form a secure connection. Double check that all wires are tightly pushed into plug sockets, so all wires make proper connections.

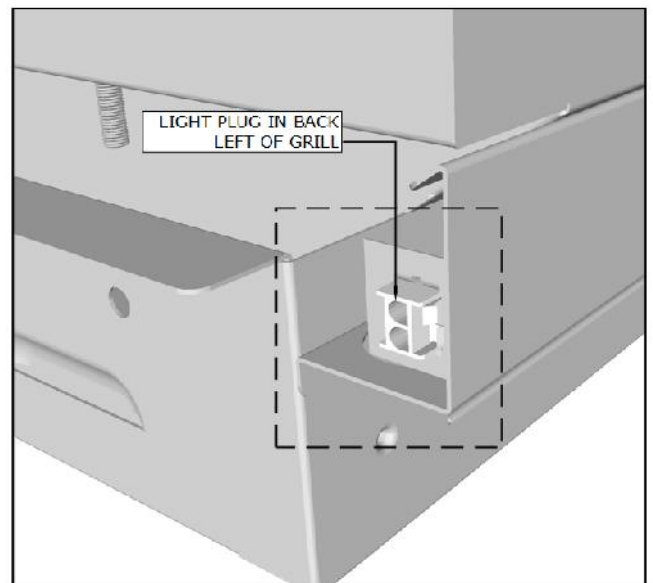

 LIVE CIRCUIT: Indicates a potentially hazard from Live electrical current that if extreme caution is not used, may result in minor or moderate personal injury, or property damage.

GRILL INSTALLATION – Propane Tank Types

Types of Propane Tanks: Propane tanks are mainly used alongside stoves, water heaters, grills, generators, and welding equipment. These bottles or metal cylinders contain propane, a type of alkaline gas that has been compressed and transformed into liquid form. Transporting, storing, and using propane safely can only be possible if it is held inside tanks or containers. Since propane has various applications, many types of tanks are being used as propane containers. Below are some common examples.

Large Capacity Tanks: Propane is delivered to your home as a very cold liquid and is pumped into a specially designed storage tank (Fig.A). The liquid changes to gas before leave's the tank. Propane tanks are typically painted white or silver to reflect heat and prevent the pressure inside the tank from getting too high.

If you have an underground tank, only the cover (Fig.B) will be visible above ground.

- The cover on top of the tank protects several components from weather and physical damage.
- The tank shut-off valve, which you can close to stop the flow of propane to your home in case of a leak or other emergency.
- The regulator, which controls the pressure of the propane gas coming out of the tank.
- The safety relief valve, which will pop open automatically if the pressure inside the tank gets too high. The valve will close again when the pressure returns to normal.
- The tank gauge, which shows the percentage of propane in the tank.

Fig. A

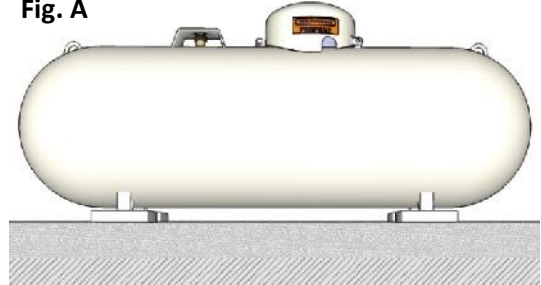
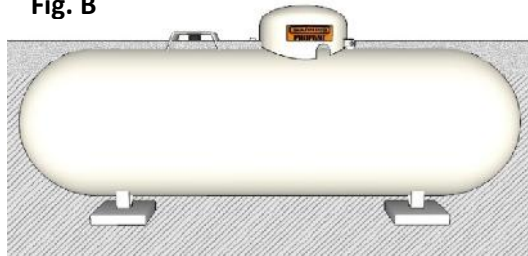

Fig. B



Propane flows from your tank to your home through pipes, most of which run underground. You may also have a secondary pressure regulator on an outside wall of your home to further adjust gas pressure. A shut-off valve in each pipe can be closed to stop gas flow to an individual appliance. An appliance connector is the final segment in the gas piping system. This specially designed flexible tube typically two or three feet long-carries gas from a pipe to the back of an appliance.

Medium Capacity Tanks

Any L.P. gas supply cylinder used with this grill must be approximately 12 inches diameter and 18 inches high. The maximum fuel capacity is 80% and is approximately 20 pounds of propane. The L.P. cylinder must have a shut-off valve terminating in a Type 1 L.P. A Type 1 compatible cylinder with a Type 1-cylinder valve has a back-check valve which does not permit gas flow, until a positive seal has been obtained.

LP Tank Filling

- Use only licensed and experienced dealers.
- LP dealer must purge tank before filling.
- Dealer should NEVER fill LP tank more than 80% of LP tank volume. Volume of propane in tank will vary by temperature.
- A frosty regulator indicates gas overfill. Immediately close LP tank valve and call local LP gas dealer for assistance.
- Do not release liquid propane (LP) gas into the atmosphere. This is a hazardous practice.
- To remove gas from LP tank, contact an LP dealer or call a local fire department for assistance.
- Check the telephone directory under “Gas companies” for nearest certified LP dealers.

GRILL INSTALLATION – Propane Tank Types



WARNING: If you have a Side Yard Propane Tank, you MUST have additional Medium Pressure Regulator located at the Grill. If you do not serious bodily harm may result or damage to the grill and island structure from HIGH Heat extremes.

Large Capacity Tank

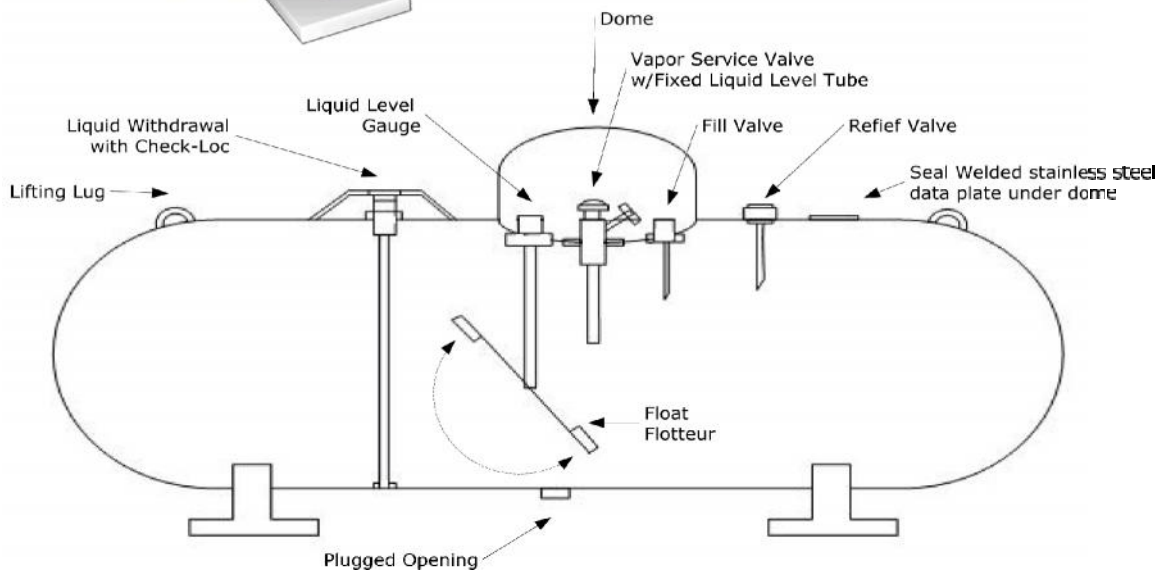
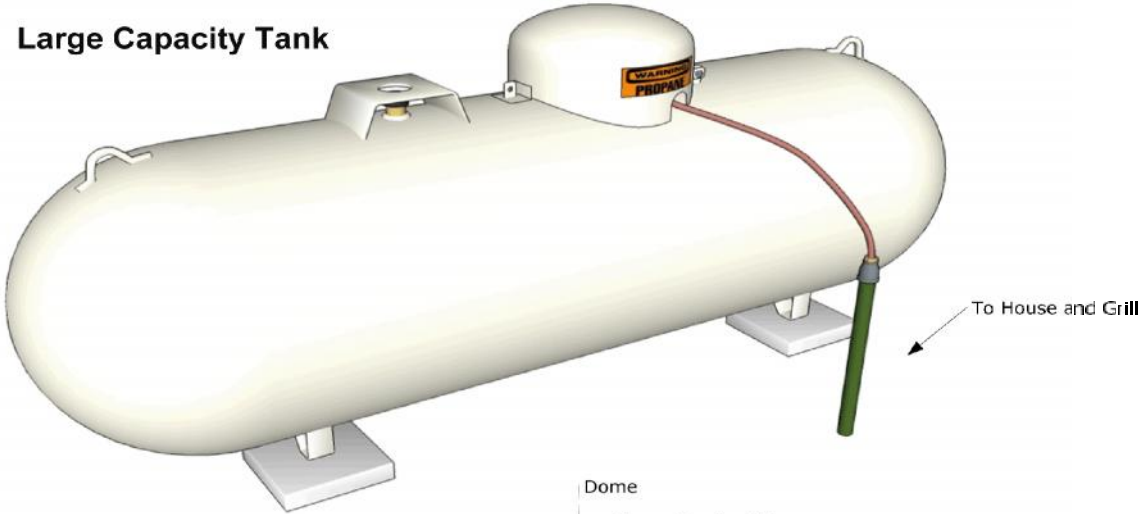

Medium Capacity Tank

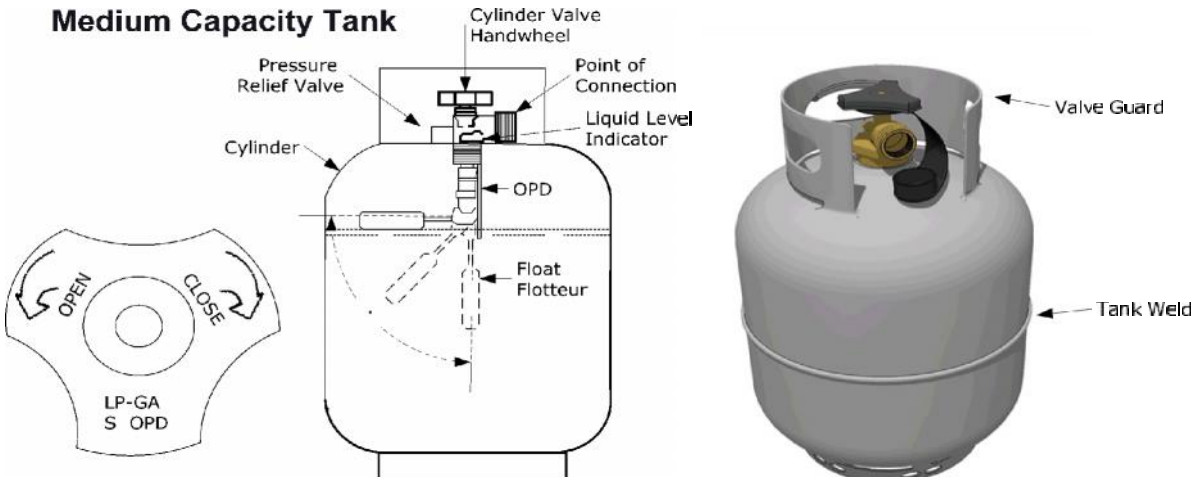

GRILL INSTALLATION – LP Gas Line Connections

1. For this type of installation, it is most similar to the NG gas installation method, only the regulator is set for liquid propane. First you will install a gas pipe, coming into island from outside, be sure the Safety Shut-Off valve is easily accessible.
2. Next, locate the gas manifold on grill, for this type of installation, the 1/2" to 3/8" flare adapter, and LP Regulator Hose that comes with your LP Grill is not needed. Gas connections are made with all 1/2" flare adapters, and UL Gas Hoses.
3. A LP REGULATOR is required for this type of installation, even if the LP Tank is installed with one already. LP regulator for grill should be set for a minimum of 120,000 BTU's with Medium Pressure. This LP grill does not come with an independent LP regulator for this type of installation. Contact the company you purchased from, or your local plumber to locate one, that is made for commercial style grills.
4. For easier connections, we recommend the Quick Connect Gas hose, to make final connection.

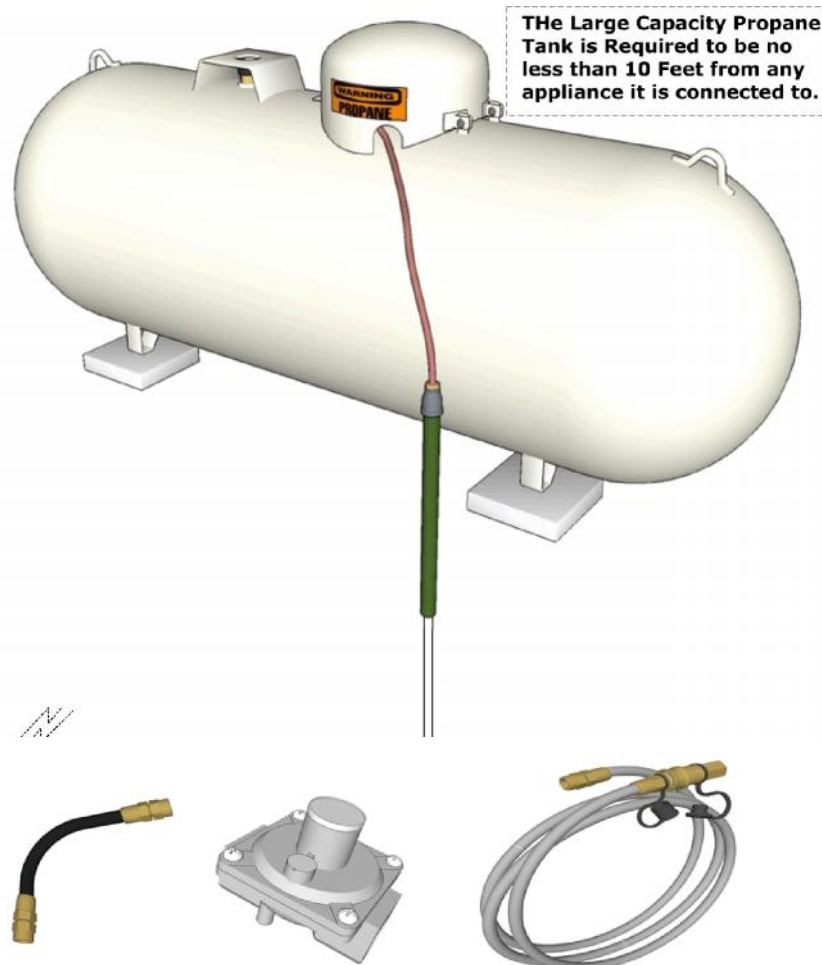

NOTE: for Large Capacity Propane Tank hook up Individual LP regulator is NOT provided, (the one provided with grill is for Medium Propane Tank)

GRILL INSTALLATION – NG Gas Line Connections

⚠ ATTENTION: Always turn grill knobs OFF, before installing gas lines, or making any connections and disconnections of supply hoses.

⚠ WARNING: Always take a leak test before lighting the grill to prevent a possible fire or explosion.

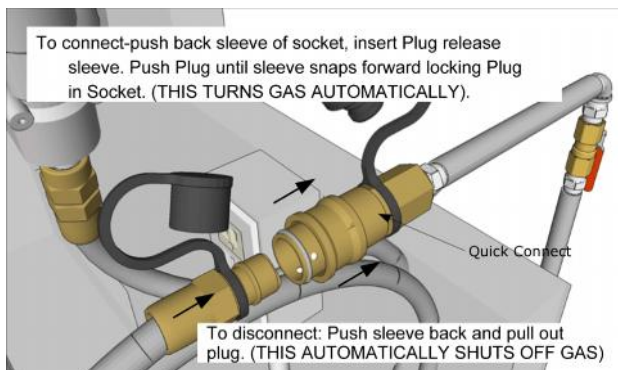
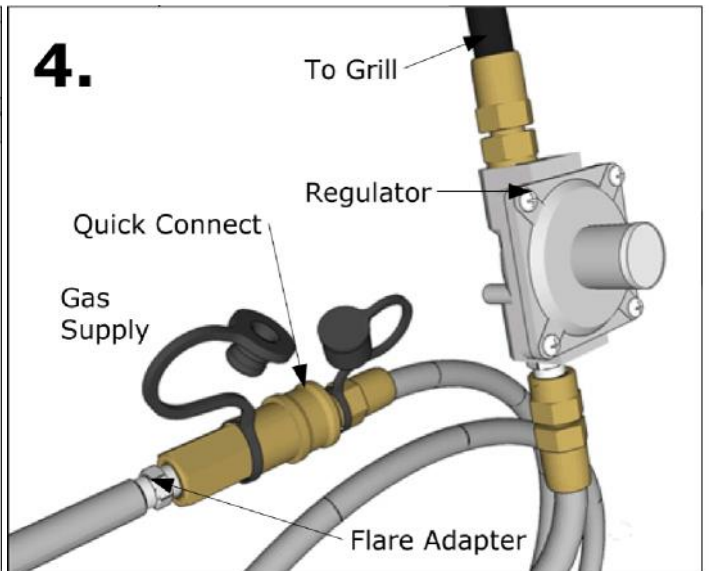
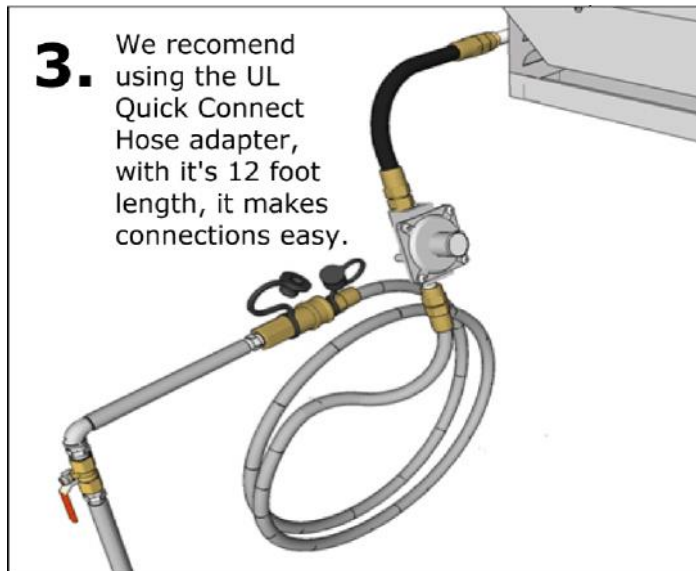
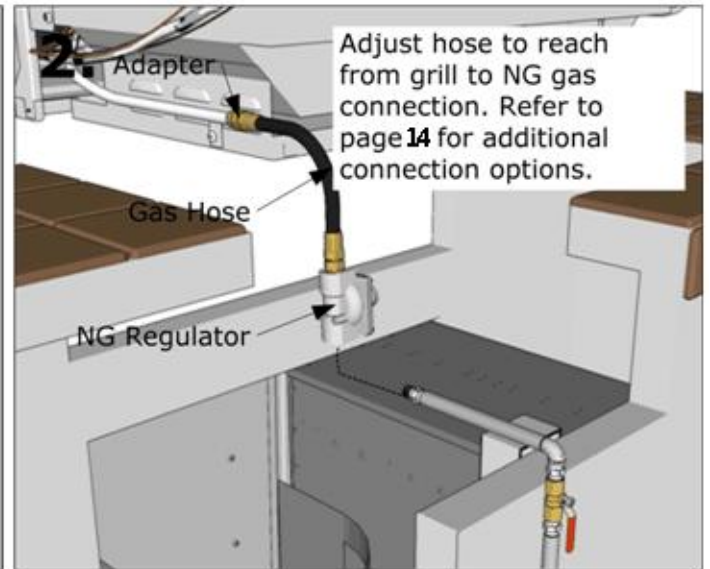
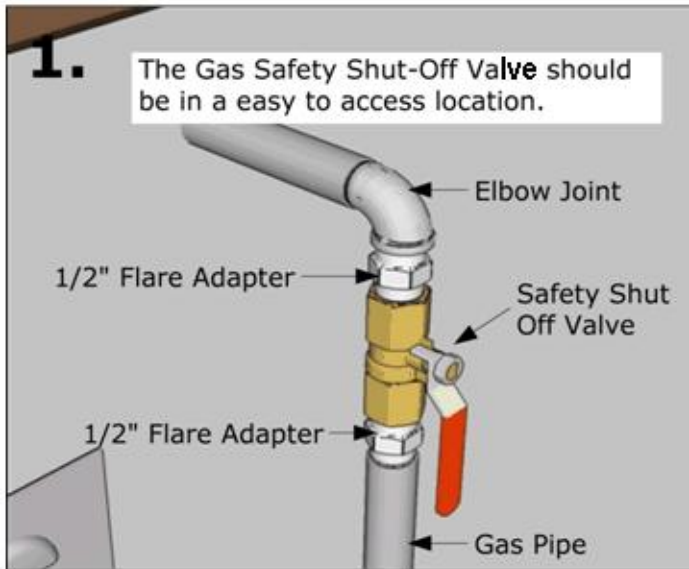

GRILL INSTALLATION – Propane Tank Connections

IMPORTANT: Before connecting grill to gas source, make sure BBQ Grill control knobs are in “OFF” position. Verify the type of gas supply to be used, either natural or LP, and make sure the marking on the appliance rating label agrees with that of the supply.

All pipe sealants must be an approved type and resistant to the actions of LP gas. Never use pipe sealant on flare fittings. The installation of this appliance must conform with local codes or, in the absence of local codes, with either National Fuel Gas Code, ANSI Z223.1/ NFPA 54, Natural Gas and Propane Installation Code, CSA B149.1, or Propane Storage and Handling Code, B149.2, or the Standard for Recreational Vehicles, ANSI A 119.2/ NFPA 1192M, and CSA Z240 RV Series, Recreational Vehicle Code, as applicable.

LP Tank Removal, Transport and Storage

- Turn OFF all control knobs and LP tank valve. Turn coupling nut counterclockwise by hand only - do not use tools to disconnect. Lift LP tank wire upward off LP tank collar, then lift LP tank up and off of support bracket. Install safety cap onto LP tank valve. Always use cap and strap supplied with valve. Failure to use safety cap as directed may result in serious personal injury and/or property damage.
- A disconnected LP tank in storage or being transported must have a safety cap installed. Do not store an LP tank in enclosed spaces such as a carport, garage, porch, covered patio or other building. Never leave a LP tank inside a vehicle which may become overheated by the sun.

The cylinder must be arranged for vapor withdrawal. It must also include a collar to protect the cylinder valve. A safety relief device having direct communication with the vapor space of cylinder must be provided. This will expel high pressure gas if the cylinder is overfilled or overheated which could result in fire or explosion.

- All L.P. gas cylinders used with this appliance shall be constructed and marked in accordance with the specifications for L.P. gas cylinders of the U. S. Department of Transportation (DOT) or the National Standard of Canada, CAN/CSA-B339, Cylinders, Spheres and Tubes for Transportation of Dangerous Goods; and Commission, as applicable; and shall be provided with a listed overfilling prevention device.
- Read labels on the L.P. Gas Supply Cylinder.
- New cylinders are always shipped empty for safety.
- Allow only qualified L.P. gas dealers to fill or repair your L.P. gas supply cylinder.
- Inform the gas dealer if it is a new or used cylinder to be filled.
- After filling, have the gas dealer check for leaks and to see that the relief valve remains free to function.

Please see the guidelines below to help ensure that you have the appropriate gas plumbing with respect to gas pipe diameter, length of pipe run and the grills BTU requirements.

GRILL INSTALLATION – Propane Tank Connections

Hose and Regulator

The Type 1 connection system has the following features:

- The system will not allow gas to flow until a positive connection has been made.
NOTE: The cylinder control valve must be turned off before any connection is made or removed.
- The system has a thermal element that will shut off the flow of gas in the event of a fire.
- The system has a flow limiting device which, when activated, will limit the flow of gas to 10 cubic feet per hour.
- NEVER use grill without leak testing.

Propane vapors are heavier than air. For this reason, they may accumulate in low-lying areas such as basements, crawl spaces, and ditches, or along floors. However, air currents can sometimes carry propane vapors elsewhere within a building

LP (Propane) Gas Supply Connection & Disconnection

LP Tank Connection

1. The tank valve should be in the “OFF” position. If not, turn the knob clockwise until it stops.
2. Make sure all burner valves are in the “OFF” position.
3. Always connect the gas supply regulator as follows: Insert the regulator inlet into the tank valve and turn the coupling nut clockwise until the coupler tightens up (see picture). Do not over tighten the coupler. Turn the main tank valve on and turn the burner control valves on the unit to the “HIGH” position for about 20 seconds to allow the air in the system to purge before attempting to light the burners.



LP Tank Disconnection

1. Turn the burner valves off.
2. Turn the tank valve off. (Turn clockwise to stop).
3. Detach the regulator assembly from the tank valve by turning them quick coupling nut Counterclockwise.

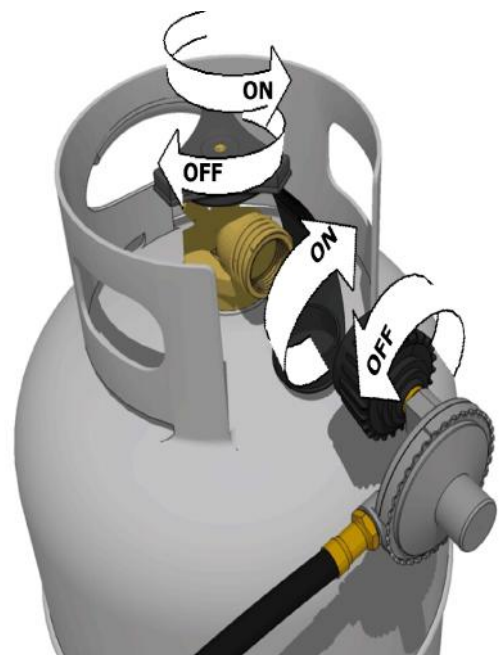

GRILL INSTALLATION – Propane Tank Connections

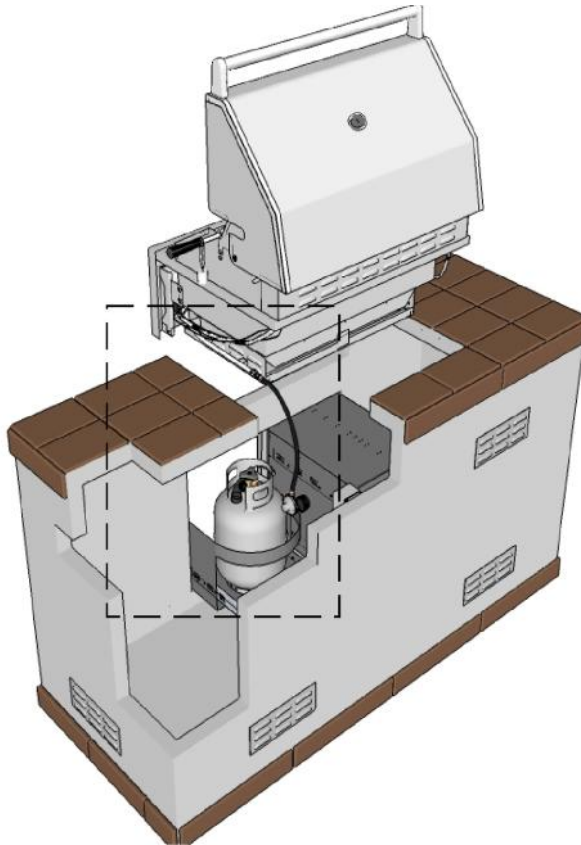

LP Gas Hook-up

This liquid propane grill is designed to operate on Liquid Propane **ONLY**. The LP gas grill is designed to be used with a standard 20 lbs gas cylinder and must be constructed and marked in accordance with specifications of the US Department of Transportation for propane gas cylinders. Always keep cylinder securely fastened in an upright position. Never connect an unregulated propane gas cylinder to the grill. Do not subject propane cylinders to excessive heat.



CAUTION: It is recommended you use a Propane Tank Pull-Out Drawer. It is severely hazardous to move propane tanks in and out of Island enclosure without assistance of drawer. See below for Sunstone's Combo Tank Tray Pull-Out Drawers available.

42" Multi-Storage-Tank Tray Slide Out

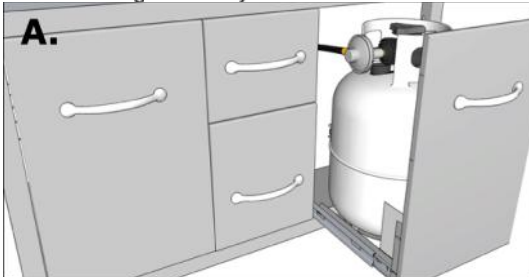

Item No. A-LPCDD42

32" Premium Multi-Storage-Tank Tray Slide Out

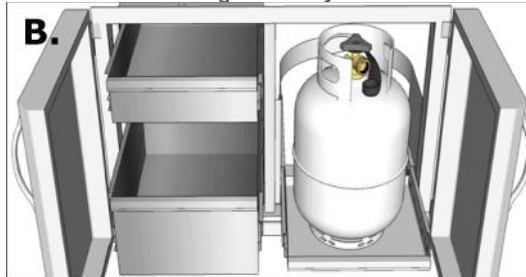

Item No. C-LPDC

32" Multi-Storage-Tank Tray Slide Out

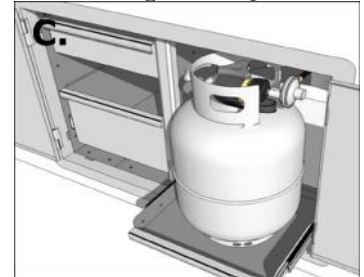

Item No. A-LPDC

30" Tank Tray Double Drawer Combo



Item No. A-LPCTD30

30" Tank Tray Double Drawer Combo

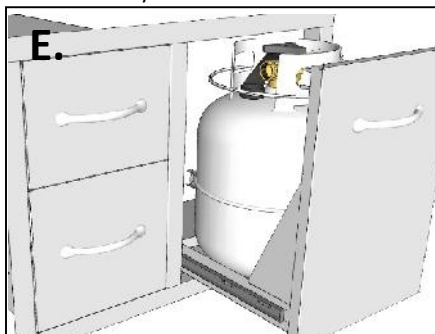

Item No. A-LPCDD30

17" Tank Tray Drawer Combo

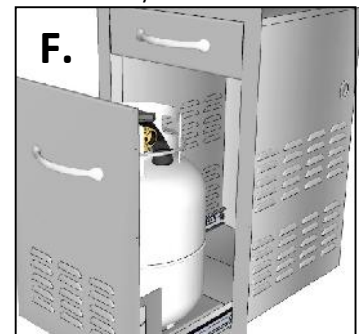

Item No. A-LPCD17

USING YOUR GRILL – Cooking Zones

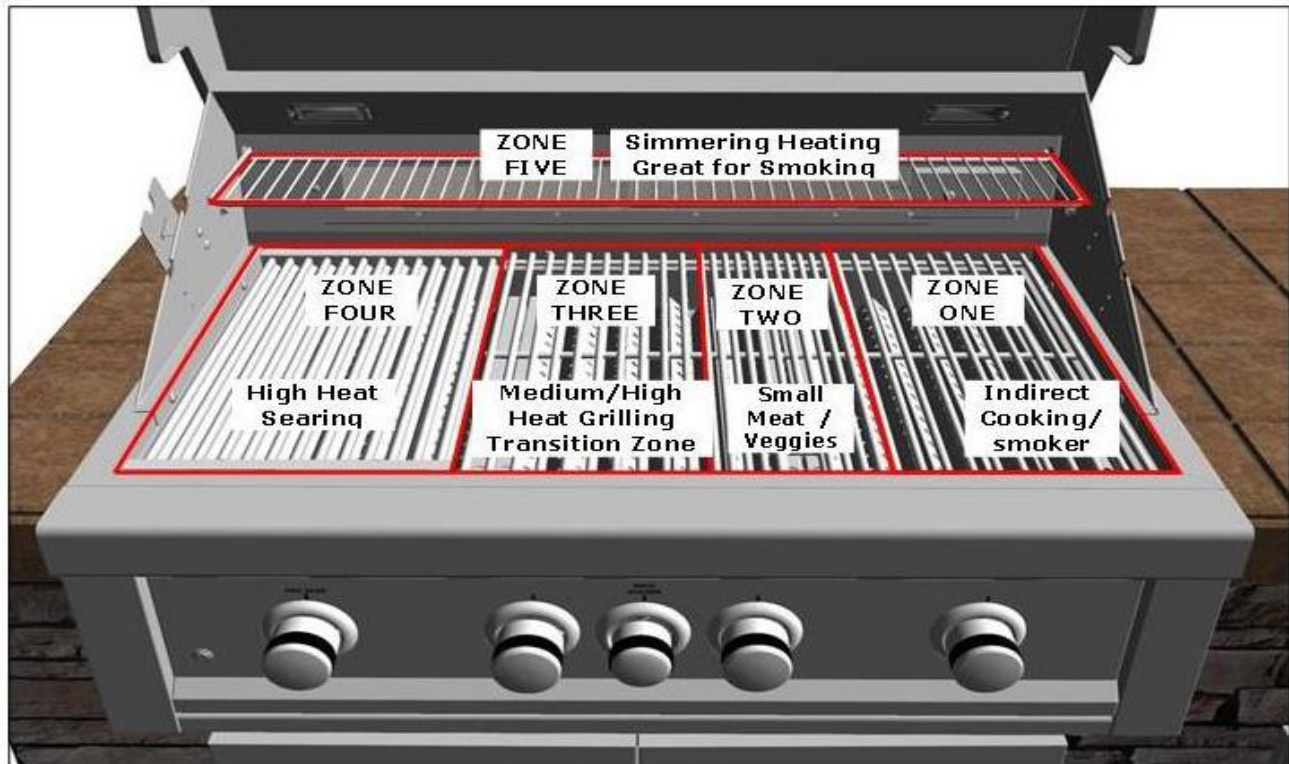

Cooking Zones

Your Ruby Grill is divided into Five Cooking Zones, depending on the number of burners you have will increase or decrease the size of each zone. Each cooking zone is designed to be controlled individually by the burner control knob. Specific zones are better suited to specific types cooking.

Variable Cooking Grids

Your Ruby Grill is designed for an exquisite cooking experience with the use of variable cooking grids and separate searing station. The Three Zones from right to left side making up the Total Grilling Space. Typical Grid Spacing is 7/8" Inch – great for larger cuts of meat, for smaller items like Hot Dogs, Vegetables like Asparagus, Mushrooms, and Peppers require the center narrower grids at just 1/2" Spacing so food items do not fall through.

Heat Distribution

The heat level at each part of the grill has been engineered for specific purposes. Knowing the heat distribution for each burner will allow you the very best possible food positioning when grilling. The front of the grill is designed, for safety reasons, to be the coolest part of the grill. From the front of the grill and moving back, the heat rises gradually until just above the burner's front edge, where it rises rapidly to a medium to high temperature. The temperature will Continue to rise to searing levels in the back. In addition, turning the back Infra-Red Burner ON will provide additional Intense Heat Source for Pass-Over Searing.

USING YOUR GRILL – Smoker/Steamer Box

Smoker/Steamer Box

Adding the smoker box to your cooking experience creates a unique flavorful experience to your food. Use it for either a smoker box with wood chips, or by filling with Water it becomes a steamer box. While in use, remember to close the hood, with the knobs set to LOW, for maximum results. There are many different wood chips available on the market, the most common ones are mesquite and hickory. Just remember to soak the chips for 30 minutes prior, for best results.

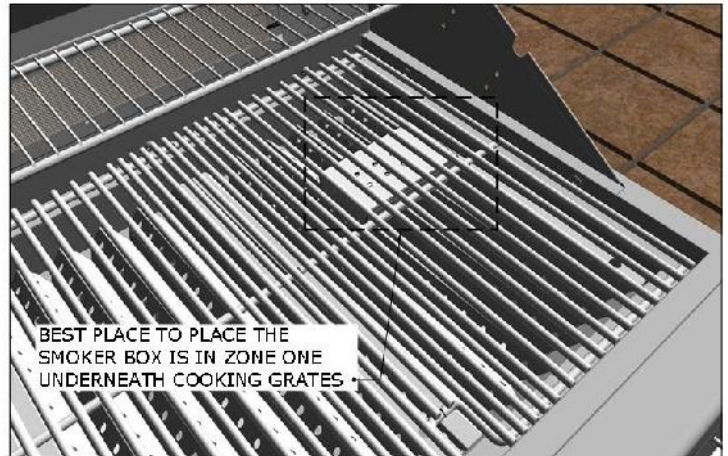

One tray of wood chips will usually last about one hour. During extended grilling, chips may need to be added several times. Lift the box only partially out of the grill to add chips while in use. Never remove the hot smoker tray completely from the grill. To improve smoke performance, keep the hood closed as much as possible while food is grilling, turn heat to Med-Low setting with hood closed.

HOW TO SMOKE:

1. Fill the smoker box with thoroughly soaked and drained wood chips.
2. Place the smoker box on the burner.
3. Place the smoker under the cooking grates, close the hood and set the smoker burner to high. Smoke should begin in about 5-7 minutes.



TYPES OF WOOD CHIPS TO USE:

Alder: Medium, tart smoke flavor. Excellent on fish, chicken.

Maple: Sweet, hearty smoke flavor. Best with fish, jerky or bacon.

Apple: Light, sweet smoke flavor. Superb with poultry, ham or sausage.

Hickory: Heavy smoke flavor. Best with beef, pork.

Mesquite: Light smoke flavor. Excellent on fish, poultry or beef.

Oak: Heavy smoke flavor. Best with beef, lamb or pork.

Pecan: Rich, sweet, versatile flavor. Good with any grilled food.

Grapevine: Strong smoke flavor. Best with beef or poultry.

Indirect Cooking

Indirect cooking is the process of cooking your food without the heat source directly under your food. You can sear meat over a high flame on one side of the grill while slow cooking on the other side of the grill – works great with smoking or steaming also. Fill your Smoker Box with Vinaigrette, Water, and Sliced Lemons for a exquisite chef style grilling. Indirect Cooking will result in tender food every time you grill.

USING YOUR GRILL- Pro Sear Burner

HEAT RISES 200 DEGREES EVERY MINUTE

TEMPERATURE INCREASES TO 800 DEGREES AT THE GRILLING SURFACE

TURN ON OTHER BURNERS FOR HIGHER TEMPERATURE

USE THE IR-BURNER FOR ADDITIONAL PASS-OVER SEARING

MOVE SEARING GRATE TO RIGHT/LEFT OR CENTER OF GRILLING SURFACE

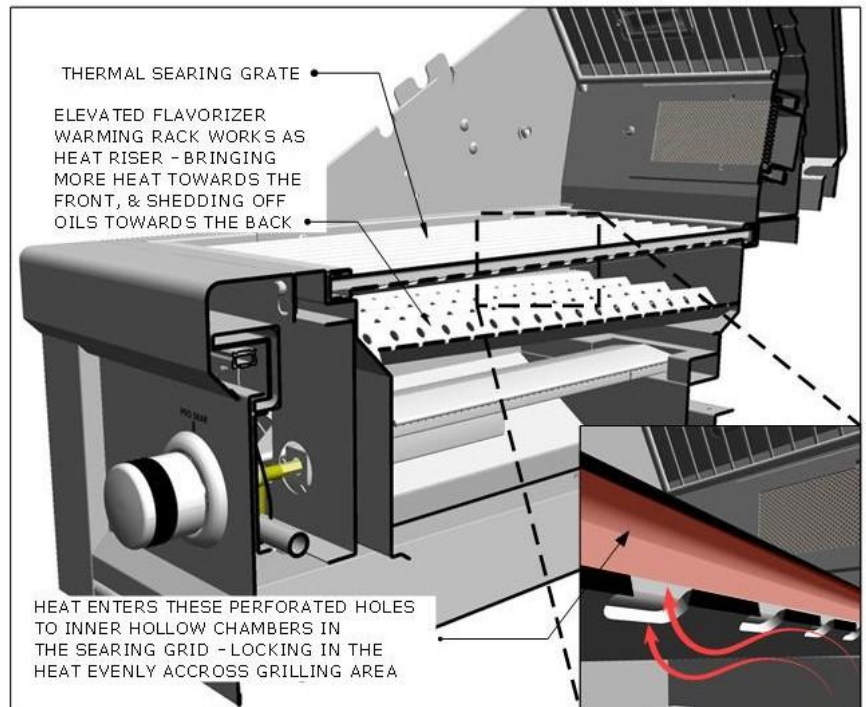

Sear Cooking Tips

Sear cooking is recommended for most grilling applications as searing locks in flavor and juices while allowing the outer surface to absorb smoke and food aroma that is produced, as grease and drippings are vaporized on searing grate. The result is a crispy, flavorful outside with a tender, juicy inside.

Your Ruby Grill is designed with a Thermal Searing Grate – shown as the Pro Sear. The Burner below matches with others, only the valve features a larger orifice for maxing out the BTU's over 20,000 for the Searing Zone. The Searing Grate is Welded Double Sided made with Heavy Duty 14 Gauge Steel with Perforated Holes on the underside with Hollow Chambers running the length of the searing surface. As heat enters these underside Perforated Holes, it fills the Hollow Chambers of the Searing Grate increasing the Surface Temperature over 800 Degrees in a very short time.

By closing the Hood, you can further increase the temperature of the searing grate. For Ease of use you can move the searing location to the left side or center of cooking surface by custom adjustments of the cooking grid locations.

USING YOUR GRILL-Burner Adjustments

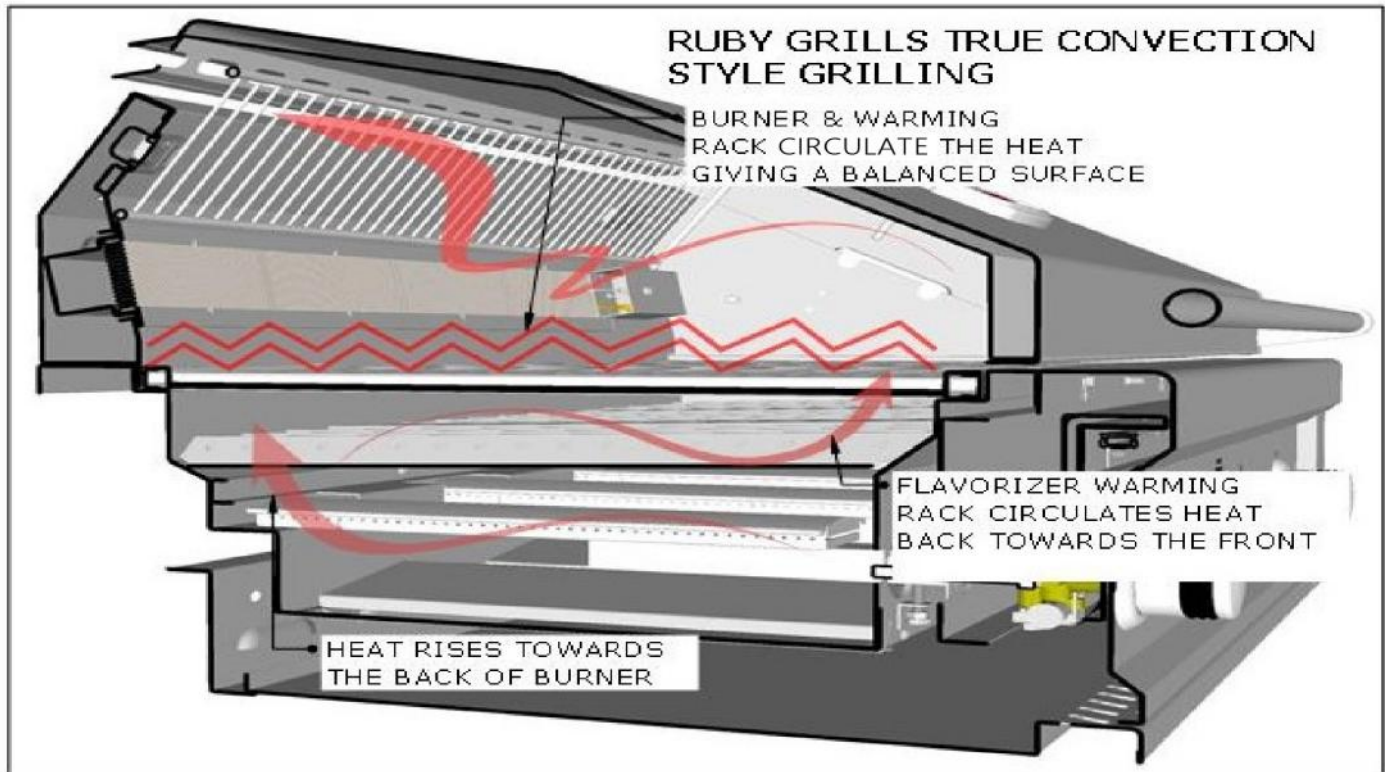

Correct Flame Color and Height

Flames should be blue and stable with no yellow tips, excessive noise or lifting. If any of these conditions exist, check if the air shutter or burner ports are blocked by dirt, debris, or spider webs. If needed, proceed with air shutter adjustment.

The amount of air which enters a burner is governed by an adjustable bolt at the inlet called an air shutter. It is locked in place by a set screw which must be loosened prior to lighting the burner for adjustment. **Flames should be blue and stable with no yellow tips, Excessive noise or lifting.**

Figure 1



FLAME SIZE

Combustion Chamber Balance

The bolt on the Right side of each burner called is called the "AIR VENTURI" and it regulates the amount of air that enters into the burner for combustion. The air venturi adjustment screw is accessible by using your hand, be sure burner is not hot.

If the flame is yellow, indicating insufficient air, turn the air venturi bolt counterclockwise to allow more air to the burner.

If the flame is noisy and tends to lift away from the burner, indicating too much air, turn the air venturi bolt clockwise.

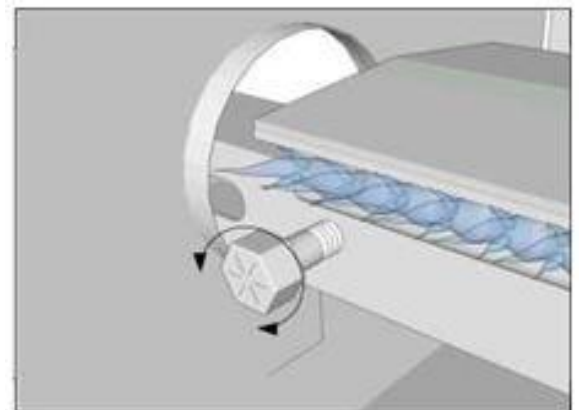

USING YOUR GRILL- Rotisserie Setup

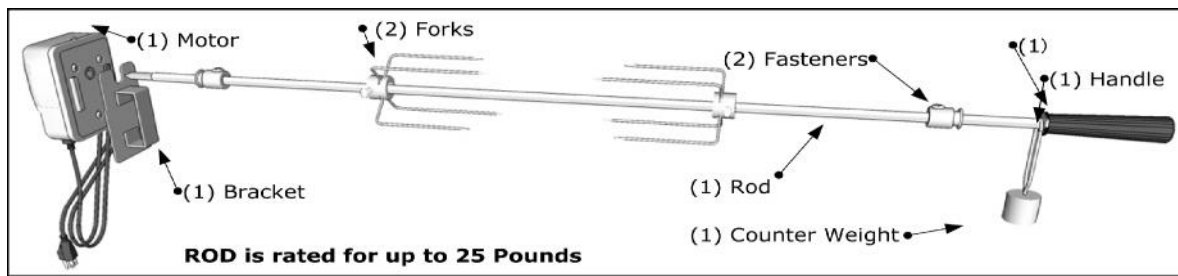

Rotisserie assembly can be purchased individually either by individual item, or in a complete set, for your size of grill. The rotisserie assembly can also be used with or without an infra-red back burner.

Name	Qty.	Part No.
3 Burner Rotisserie set	1	P-RK-3B
4 Burner Rotisserie set	1	P-RK-4B
5 Burner Rotisserie set	1	P-RK-5B

1. Insert Rotisserie Motor into Motor Bracket Assembly.
2. Slide Prong Forks with the prongs facing away from the handle into Spit Rod. So that any food item will be in the center between the two four prong forks.
3. Assemble Key Washer, Counter-balance and handle to Spit Rod. Slide Shaft Collar with long end towards handle.
4. Insert motor extension cord three prong plug into an adjacent grounded GFCI receptacle outlet.
5. Before placing food item on forks when the rotisserie is being operated exclusively, it is strongly recommended that a pan be placed on the grilling grids, beneath the food to catch the meat drippings. This will prevent excessive build up of drippings on the grids and facilitate cleaning. When food item is placed on rotisserie, be sure that all Bolts are tightened securely.
6. Preheat the grill by setting all the burners on high, once hot, turn off all but the rear burner. The spit hangs over the front or center burner, so that the meat is not directly over the heat. Preheat the grill, then turn the burners to low. Place a drip pan on the grill below the meat. Add about 1/2 inch of water to the drip pan.
7. Place the first pair of prongs onto the spit, then push the meat onto the spit and into the prongs. Add the other set of prongs and push them into the meat securely anchoring it onto the spit. Tighten the wing nut that holds the prongs in place and attach the spit to the brackets on either side of the rotisserie.
8. The rotisseries rod comes with a counter balance weight, adjust it as needed. Start the motor and make sure the meat is balanced on the spit so that it turns evenly. You may need to adjust the grate and drip pan if your meat is large. Make sure the meat can turn with no obstructions.
9. Close the lid while the rotisserie does its job. The rotation evenly melts the fat in the meat and naturally bastes the meat, but you may wish to baste with a mop sauce occasionally during grilling. Check the meat with a meat thermometer for doneness before turning off the heat. When done, remove the spit using insulated oven mitts. Place the meat on a clean platter and cover it with foil while it rests.

Electrical Grounding Instructions:

The rotisserie motor is equipped with a three-prong grounding plug for your protection against electric shock. This plug must be inserted directly into a properly grounded three-prong receptacle. Do not cut or remove the grounding prong from this plug.

The rotisserie motor must be electrically grounded in accordance with local codes or, in the absence of local codes, in accordance with the National Electrical Code, ANSI/NFPA 70-1990 or Canadian Electrical Code, CSA C22.1.

Do not use an extension cord to supply power to your grill. Such use may result in fire, electrical shock or other personal injury. Do not install a fuse in the neutral or ground circuit. A fuse in the neutral or ground circuit may result in an electrical shock hazard. Do not ground this appliance to a gas supply pipe or hot water pipe.

USING YOUR GRILL- Rotisserie Cooking

⚠️ WARNING: Never stand with your head directly over the Grill when preparing to light the Rotisserie burner, to prevent possible bodily injury. Never operate Rotisserie Burner with main (other) burner(s) “ON” . Warming Rack must be removed or in Tilt-Away Position when Rotisserie Burner is ON.

INSTALL AS A SINGLE POSITION IN EITHER HIGH OR LOW POSITION, MOUNT MOTOR ON EITHER LEFT OR RIGHT SIDE POSITION

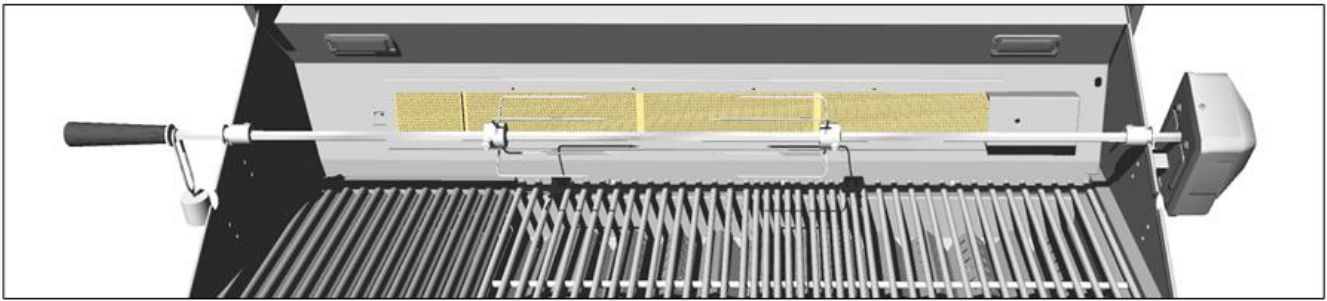

INSTALL DOUBLE POSITIONS IN BOTH HIGH & LOW POSITION, MOUNT MOTORS CRISS-CROSS FROM EACH OTHER, DO NOT USE ROT. ROD WEIGHT.

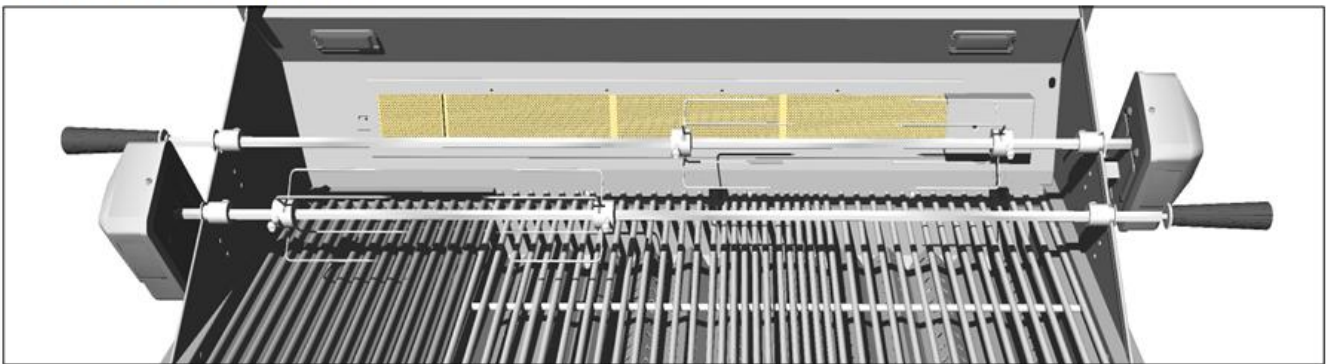

Rotisserie Cooking Tips

Rotisserie is mostly used to cook large piece of meat and poultry to assure slow, even cooking. The constant turning provides a self-basting action, making food cooked on a rotisserie exceptionally moist and juicy. Rotisserie cooking generally requires 1 ½ to 4½ hrs. to cook depending on the size and type of meat being cooked. You can have rotisserie cooking with indirect heat or with infrared rotisserie burner. Preferred by professional chefs over other methods, the intense heat is ideal for searing in the natural juices and nutrients found in quality meat. For successful rotisserie, the meat should be centered and balanced as evenly as possible on the spit rod to avoid overworking the rotisserie motor.

Your Ruby Grill is designed with High & Low Spit Rod positions, the Low position centers your meat in the grills body, while the high positions bring it closer to the back Infra-Red burner for High Heat Searing. Also, you can place up to Two Rotisserie Rods and Motors Criss-Crossed as shown in the above example for Setup of your Rotisserie Assembly.

USING YOUR GRILL –Lighting the Rotisserie

IR-Burner Lighting Instructions

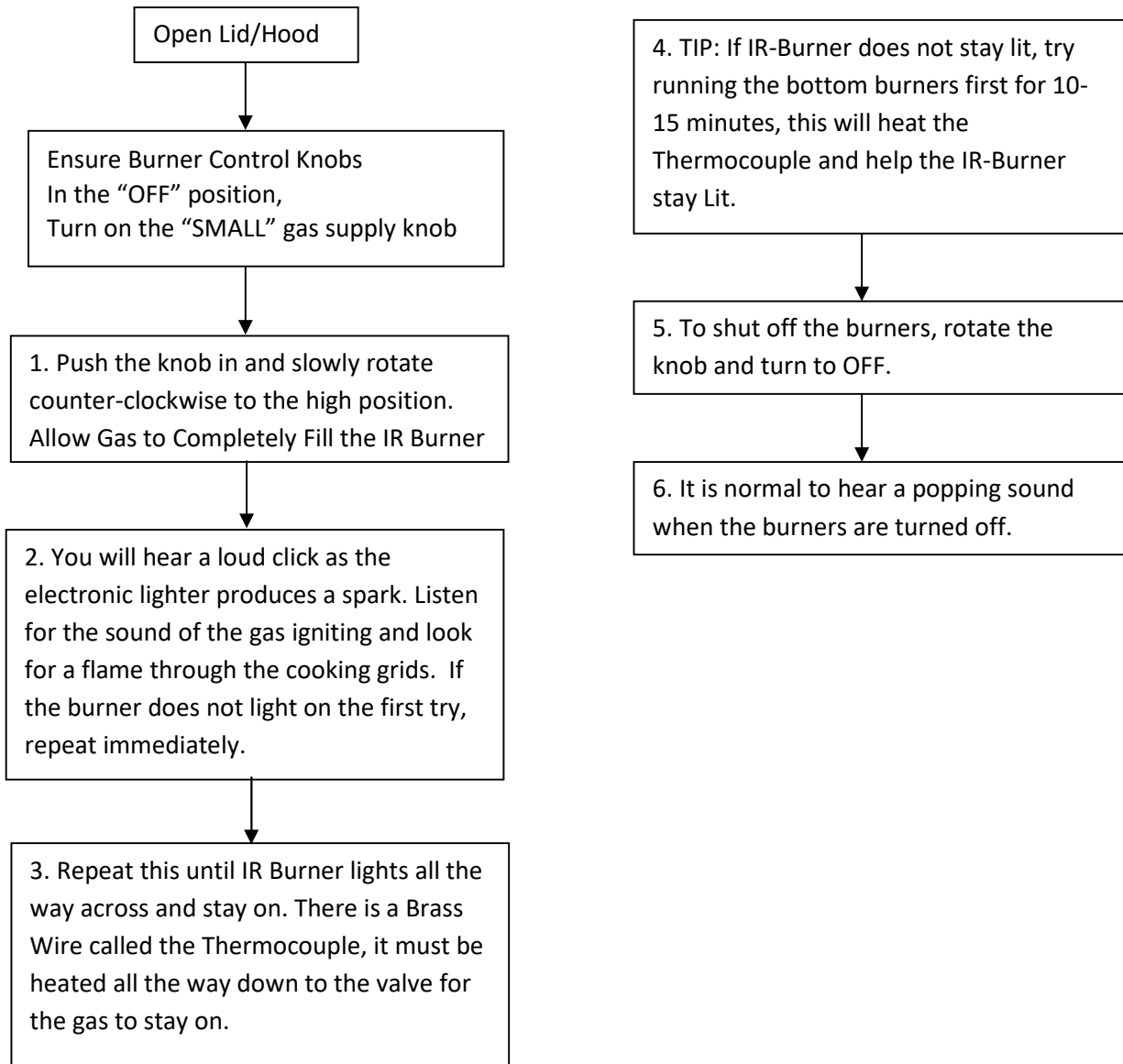

SAFETY CHECKS –Leak Test



WARNING: Always take a leak test before lighting the grill to prevent a possible fire or explosion. Never store a spare propane cylinder in the vicinity of this Grill, or in the vicinity of any other potential heat source. Never attempt to attach this grill to the self-contained LP gas system. Do not use grill until leak testing.



Before Testing

DO NOT smoke while leak testing. Extinguish all open flames. Never leak test with an open flame or risk of serious harm to self or others.



Mix Solution

Prepare a leak testing solution of soapy water by mixing in a spray bottle one part liquid soap to one part water. You can also use mild detergent or liquid soap and water.

Leak Testing Procedure

Perform a leak test at least once a year whether the gas supply cylinder has been disconnected or not. In addition, whenever the gas cylinder is connected to the regulator or whenever any part of the gas system is disconnected or replaced, perform a leak test.

As a safety precaution, remember to always leak test your grill outdoors in a well-ventilated area. Never smoke or permit sources of ignition in the area while doing a leak test. Do not use a flame, such as a lighted match to test for leaks. Use a solution of soapy water.

1. Make sure all the control knobs are in the OFF position.
2. Turn on the gas.
 - a. On natural gas systems, turn the shut off valve to the grill.
 - b. On LP systems, turn the propane tank valve knob counter clockwise one turn to open.
3. Apply the leak-testing solution by spraying it on joints of the gas delivery system. Blowing bubbles in the soap solution indicates that a leak is present.
4. Stop a leak by tightening the loose joint or by replacing the faulty part with a replacement part recommended by the manufacturer. Do not attempt to repair the cylinder valve if it is damaged. The cylinder must be replaced.

SAFETY CHECKS –Leak Test

Liquid Propane Leak Testing Procedure

Test connection from LP Tank to Regulator

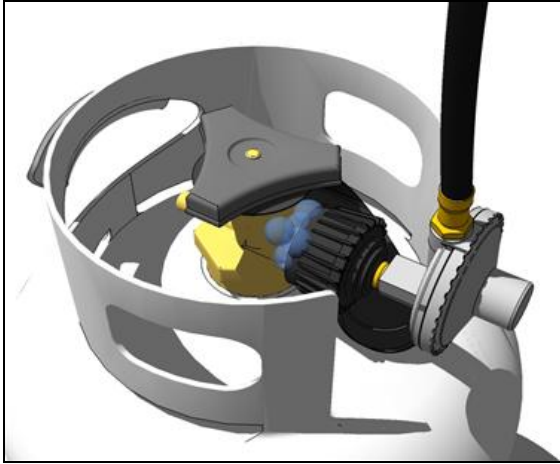

Test connection from grill to LP Hose

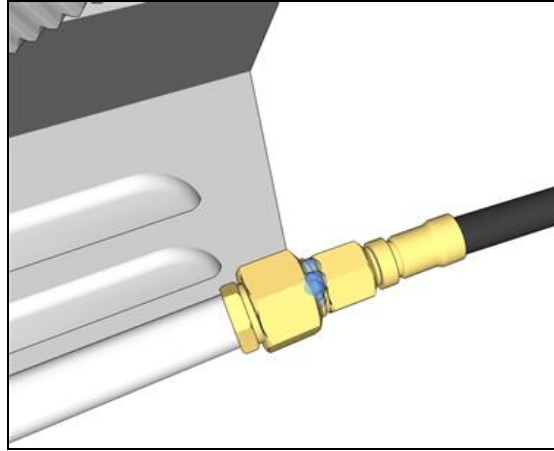

Natural Gas Leak Testing Procedure

If unable to stop gas leak, turn gas off

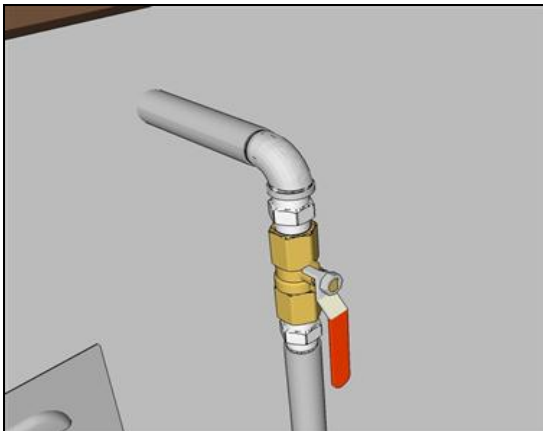

Test connection next to NG regulator

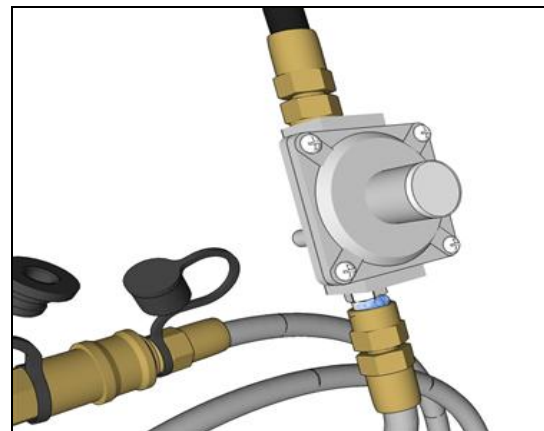

Test connection from gas line to adapter

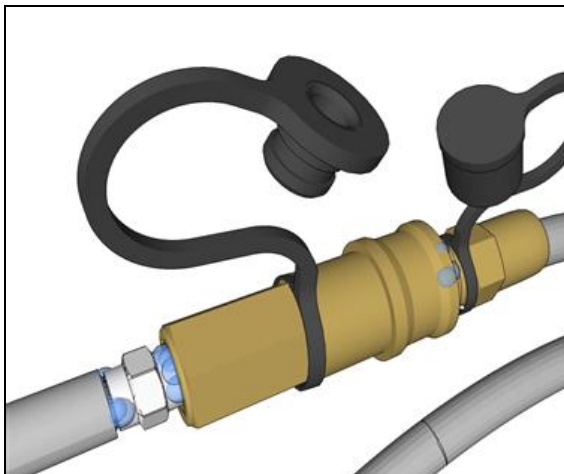

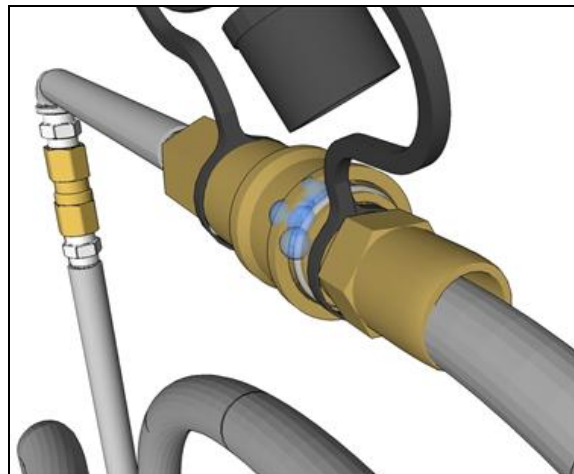

Test Quick Disconnect





SAFETY CHECKS –Attention & Warnings

 **WARNING:** When Lighting the Grill. DO NOT RELEASE KNOB, GAS WILL CONTINUE TO FLOW.

 **WARNING:** Keep any electrical supply cords and the fuel supply hose away from any heated surfaces.

 **WARNING:** Failure to open the lid while igniting the barbecue's burners, or not waiting 5 minutes to allow the gas to clear if the barbecue does not light, may result in an explosive flame-up which can cause serious bodily injury or death.

 **CAUTION:** Inspect the hose before using the grill. If there is excessive abrasion or wear, or if the hose is cut, it must be replaced prior to the outdoor cooking gas appliance being put into operation. The replacement hose assembly shall be that specified by the manufacturer. Ensure the area around the barbecue is clear of flammable substances such as gasoline, yard debris, wood, etc. Ensure there is no blockage of the airflow through the vent space located below the face of the unit.

 **WARNING: OUTDOOR USE ONLY:** NEVER operate grill in enclosed areas, as this could lead to gas accumulating from a leak, causing an explosion or a carbon monoxide buildup which could result in injury or death. DO NOT use your grill in garages, breezeways, sheds or any enclosed area. NOT FOR USE BY CHILDREN. If these instructions are ignored, a hazardous fire or explosion could result in physical injury, death or property damage!

 **WARNING:**

1. DO NOT Store or use gasoline or other flammable liquids or vapors in the vicinity of this or any other appliance.
2. An LP cylinder not connected for use shall not be stored in the vicinity of this or any other appliance.

GRILL START-UP - Grill Safety

CAUTION

Do Not close grill hood for more than 7 minutes with burners set to HIGH temperature, or damage may occur to grill that is not covered under manufacture warranty.

CAUTION

When using your Grill, always cook with hood up when knobs are on HIGH HEAT setting. NEVER close the hood and walk away. Always turn burners to LOW HEAT when hood is in down position

Grill Operation.

If a burner goes out, turn burner knobs to full OFF position, fully open the grill hood and let any gasses out. Do not attempt to use the grill until the gas has had time to dissipate.

Never use the grill if the drip pan is not properly installed. Drip pan should be pushed all the way into the rack located just under the grill. Fire or explosion can result from an improperly installed drip pan. Keep all electrical supply cords and the rotisserie motor cord away from the heated areas of the grill. Never use the grill or side burner in windy conditions. If used in a consistently windy area a windbreak will be required. Always adhere to the specified clearances listed in this manual.

Never allow clothing, pot holders or other flammable materials meet or be close to any grate, burner or hot surface until it has fully cooled. Never wear loose fitting or hanging garments while using your grill.

Fabric may ignite and result in personal injury. Do not heat any unopened glass or metal container of food on the grill. Pressure may build up and cause the container to burst, possibly resulting in serious personal injury or damage to the grill. Do not reach over your grill or any other surfaces when hot or in use.

Do not use water on grease fires. Never pick up a flaming pan. Turn the appliance off and smother the flaming pan with a tight-fitting lid, a cookie sheet or a flat tray. For flaming grease outside of the pan, smother it with baking soda or use a dry chemical or foam-type fire extinguisher. When your gas grill is not in use, turn off the gas at the supply cylinder. Storage of a grill indoors is permissible only if the supply cylinder is disconnected and removed. We recommend commercial quality aluminum pans and utensils.

Never leave the grill and side burners unattended when in use. When using pots and pans, boil- overs will cause smoking and greasy boil-overs may ignite.



Spiders and other insects can nest in the burners of the grill and block the gas and airflow to the burner ports. This creates a dangerous condition that can result in a fire behind the valve panel. Inspect and clean the burners periodically and follow the guidelines in the Cleaning and Maintenance section of this manual.

GRILL START-UP –Lighting the Grill

Lighting Instructions

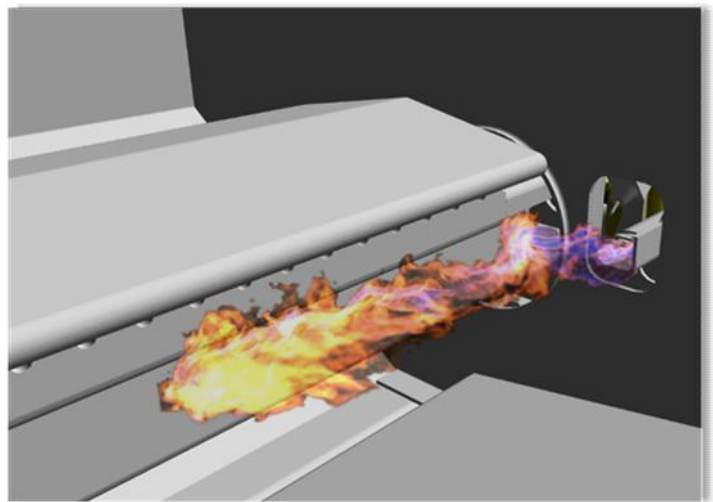
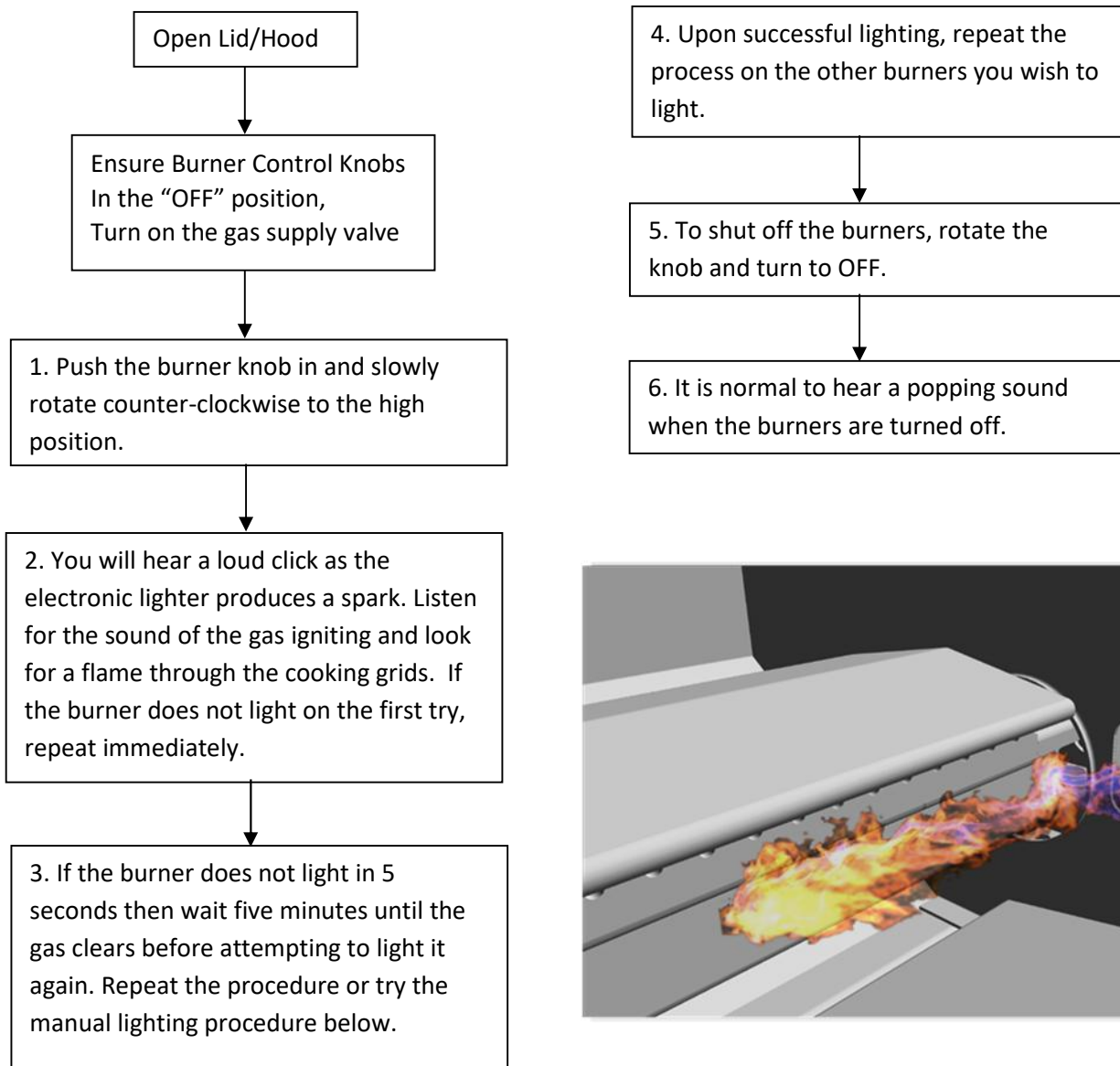

NOTE: To light gas grill with a gas lighter, make sure the grill has been leak tested and burners be properly located. Insert long-necked gas lighter through the cooking grid, and in through an adjacent side port hole of the Flavorizer grid, placing near a burner side. Turn the closest burner knob on to “HIGH” setting to release gas. Turn on the button on gas lighter, burner should light immediately. Adjust burners to desired cooking temperature.



CARE & MAINTANCE –Cleaning the Grill

ANNUAL CLEANING OF GRILL HOUSING

Burn-off the grill after use will keep it ready for instant use, however, once a year you should give the entire grill a thorough cleaning to keep it in top operating condition.

1. Shut off gas supply at source and disconnects fuel line. Protect fuel line fitting.
2. Remove and clean the cooking grids, flavorizers and burners.
3. Remove warming rack and wash with mild detergent and warm water.
4. Cover the gas valve orifices with a piece of aluminum foil.
5. Brush the inside and bottom of the grill with a stiff wire brush, and wash down with a mild soap and warm water solution. Wash thoroughly and let it dry.
6. Remove aluminum foil from orifices and check orifices for obstruction.
7. Check electrode.
8. Reinstall flavorizers, cooking grids, and warming rack.
9. Reconnect to gas source and observe burner flame for correct operation.

IMPORTANT: You should NOT line the bottom of the grill housing with aluminum foil, sand or any other grease absorbent substance. Grease will not be able to drip into the drip tray and a grease fire may occur.

MAINTENANCE GUIDELINES

1. Keep outdoor cooking gas appliance area clear and free from combustible materials, gasoline and other flammable vapors and liquids.
2. Do not obstruct the flow of combustion and ventilation air.
3. Keep the ventilation opening(s) of the cylinder enclosure free and clear from debris.
4. Visually check burner flames. Burner flames should be blue and stable with no yellow tips, excessive noise, or lifting.
5. Clean outdoor cooking gas appliance, including special surfaces, with recommended cleaning agents, if necessary.
6. Check and clean burner for insects and insect nests. A clogged tube can lead to a fire beneath the grill.

RUST-BROWN MARKS:

When this type of staining occurs, it is unlikely that rusting of the stainless steel itself causes the marks. Similar marks can be found with both porcelain and plastic sinks. The rust marks are the result of small particles of “ordinary-steel” which have become attached to the surface; these have subsequently rusted in the damp environment. The most common source of such particles is from “wire wool” scouring pads, but contamination may also occur from carbon steel utensils and old cast iron water supply pipes. These brown marks are only superficial stains, which will not harm the Grill; they should be removable using a soft damp cloth and a multi-purpose cream cleanser. Occasionally, it may be necessary to resort to a proprietary stainless-steel cleanser, to return the surface of the Grill to its original condition. To avoid re-

occurrence of any “rust-staining” it is essential that the source of the contamination be eliminated.

PITTING:

Another form of corrosion, which occasionally occurs in stainless steel, is pitting of the surface. The reason for this corrosive attack can usually be attributed to certain household products. Such as.

BLEACHES:

Most common domestic bleaches & sterilizing solutions contain chlorine in the form of sodium hypochlorite. If used in concentrated form, bleaches can attack the stainless steel, causing pitting of the surface. They should always be used to the strengths prescribed by the manufacturer and should be thoroughly rinsed off with clean water immediately after use. All cleaning agents containing hypochlorite are unsuitable for long term contact with stainless steel and, even when used in the highly diluted form, they can give pitting under certain conditions.

FOODSTUFFS:

In general, stainless steel is fully resistant to all foodstuffs in common use. Only in isolated cases, such as when concentrated salt and vinegar mixtures can remain in contact with the steel for a long period can any surface marking result.

CARE & MAINTANCE – Opening Panel

When performing a Gas Conversion, Opening the Panel is the First Step to converting the grill from either Liquid Propane or Natural Gas. Always Turn-Off and Disconnect any Gas Lines or Connections from the grill, before performing any service or conversion on the grill.

1. ROTATE KNOBS TO REVEAL HOLE, INSERT SMALL ALLEN WRENCH FOUND WITH PRODUCT MANUAL

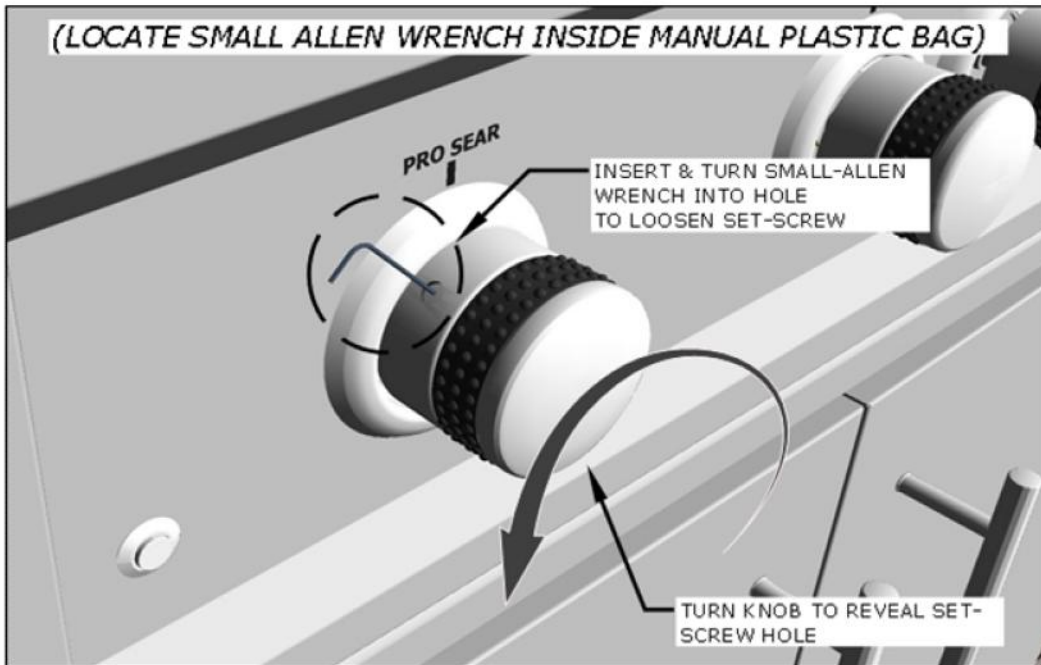

2. REMOVE COOKING GRATES, ALL KNOBS & DRIP PAN ONLY & PLACE ON SIDE COUNTER

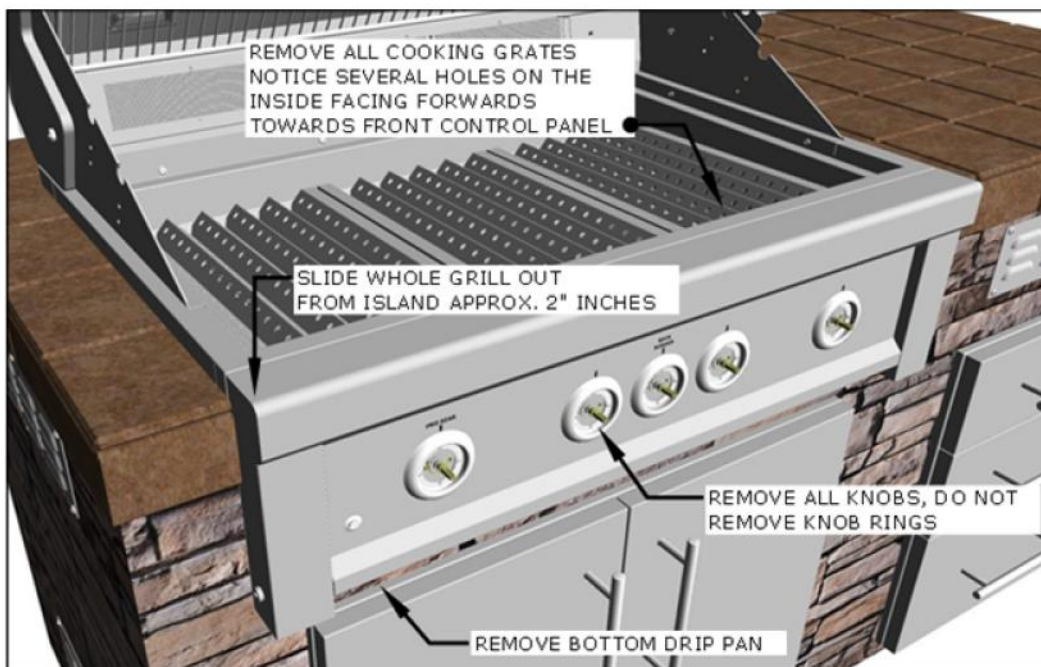

CARE & MAINTANCE – Opening Panel

3. LOCATE LARGE ALLEN WRENCH WITH PRODUCT MANUAL, REMOVE BACK CONTROL PANEL SCREWS



4. GRIP CONTROL PANEL TOP LIP, AND LIFT UP RELEASING PANEL, ALLOW IT TO DROP OPEN

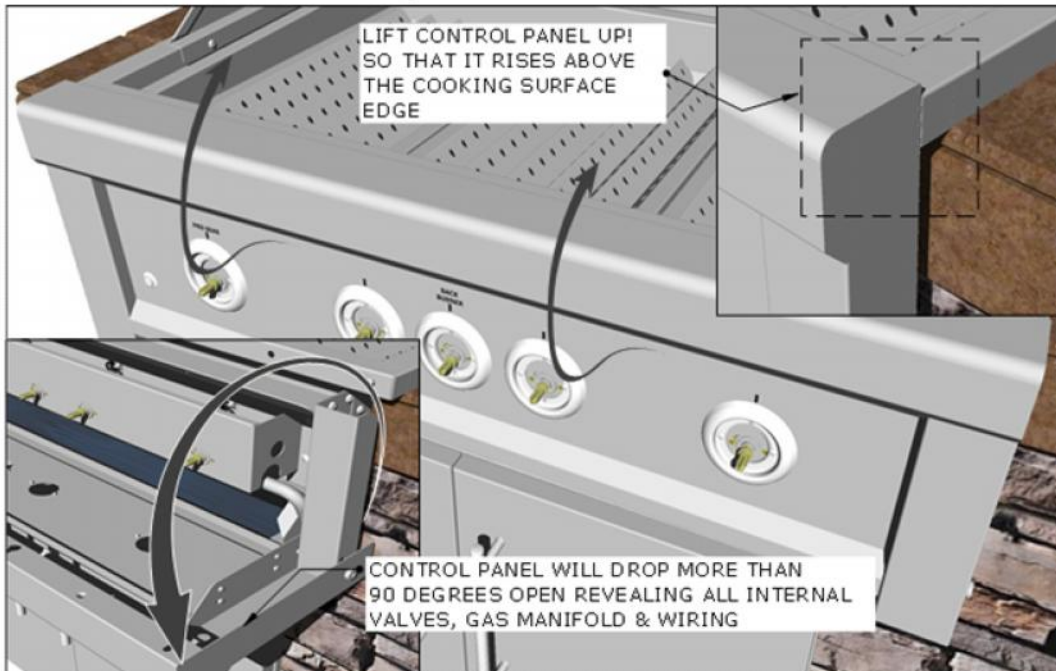

GAS CONVERSION – Getting Started



DANGER!

Disconnect the Gas Line from back of grill, and Turn the Gas Supply OFF to the grill before performing Gas Conversion. Serious Injury may result if Gas is Left ON.

Parts Needed for each Gas Conversion Type

NG to LP Conversion:

LP Valve – Need 3 , 4 or 5
depending number of burners



R-Rvalve for LP

Safety Valve for NG (With IR Burner)

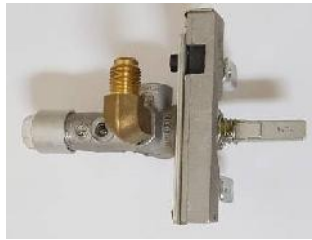

R-RSvalve for LP

LP Regulator LP-Reg



1/2" to 3/8" Flare Adapter

Item No. P-MAdapter-LP



LP IR-Flare Adapter

Item No. P-Orifice-IR for LP
(With IR Burner)



LP to NG Conversion:

#50 Drill Bit



NG Regulator



Safety Valve for NG (With IR Burner)



Item No. R-RSvalve for NG

1/2" Flare

Item No. P-MAdapter-NG



NG IR-Flare Adapter

Item No. P-Orifice-IR for NG
(With IR Burner)



GAS CONVERSION – Accessing Valves

The Following section is for converting your Ruby Grill from **NG to LP** or **from LP to NG**. While performing this conversion, make sure your Gas line is Disconnected from the Grill and Gas is turned Off.

1. USING PHILIPS SCREW DRIVER, REMOVE THE TWO SCREWS AT EITHER END OF VALVE PANEL



2. IDENTIFY COMPONENTS - REMOVE PARTS IF NECESSARY THEN SLIDE VALVE ASSEMBLY OUT

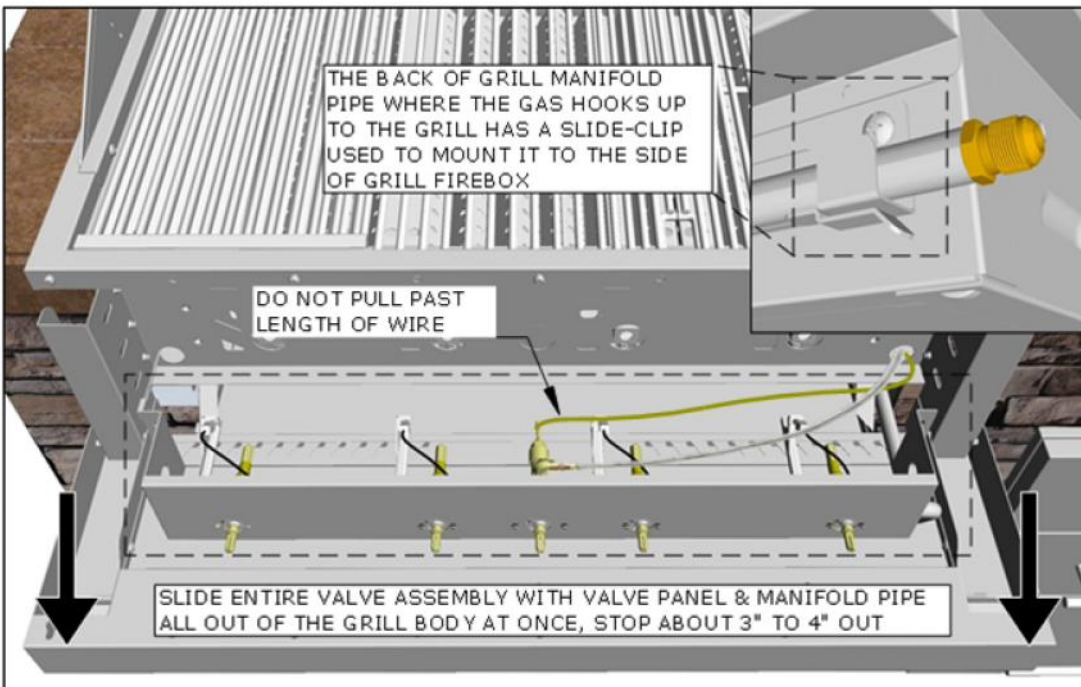

GAS CONVERSION – Convert Safety Valve

The Following section is for converting your Ruby Grill Safety Valve for **Either LP to NG or NG to LP**, for all grills with an Infra-Red Back Burner. Skip this section if your grill does not have this part.

1. REMOVE SAFETY VALVE FLEX HOSE, & BRASS WIRE, "THERMOCOUPLER"

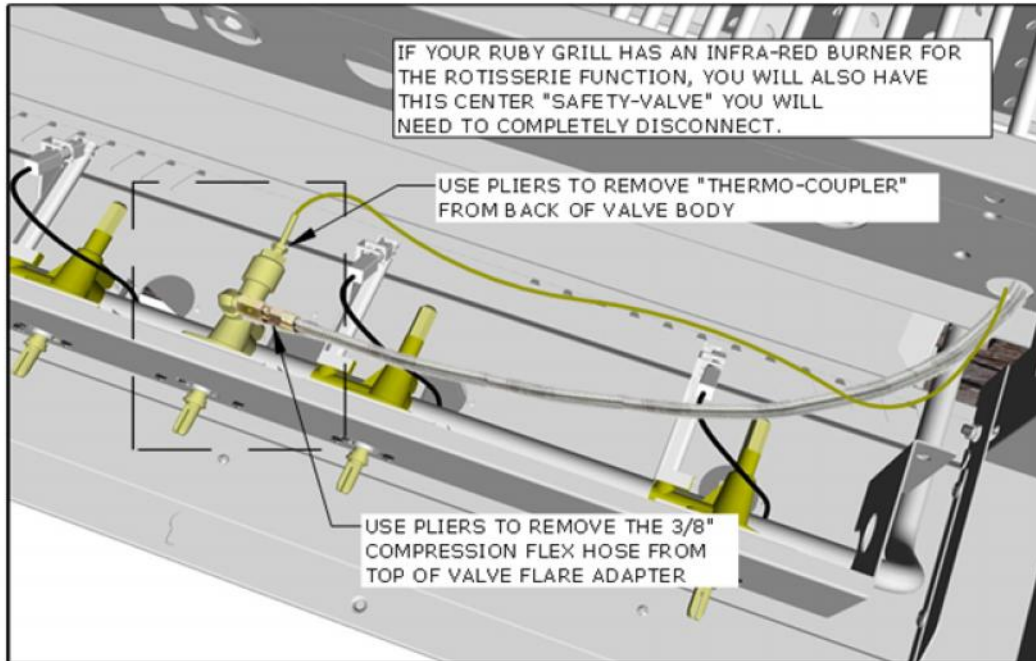

2. REMOVE SAFETY VALVE AND SWAP FOR OTHER GAS TYPE EITHER LP OR NG

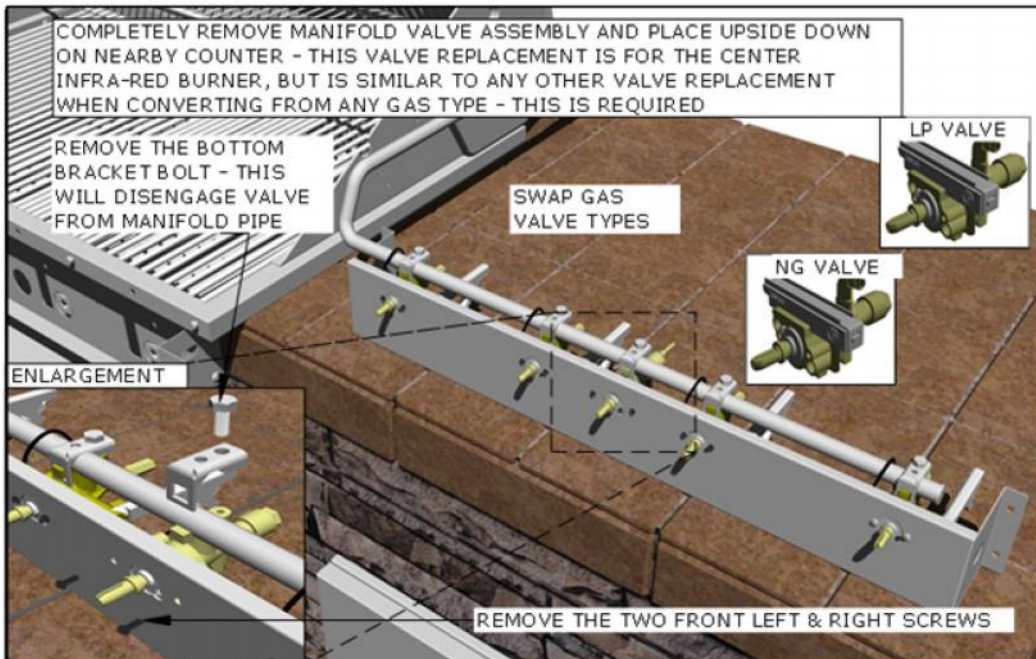

GAS CONVERSION – IR Burner Flare Adapter

The Following section is for converting your Ruby Grill Safety Valve for **Either LP to NG or NG to LP**, for all grills with an Infra-Red Back Burner. Skip this section if your grill does not have this part.

3. LOCATE THE PANEL ON THE BACK RIGHT SIDE, REMOVE TO ACCESS IR BURNER FLARE ADAPTER



4. REMOVE BRASS O-RING, THEN PULL OUT ADAPTER & ROTATE OUT REVEALING FLARE

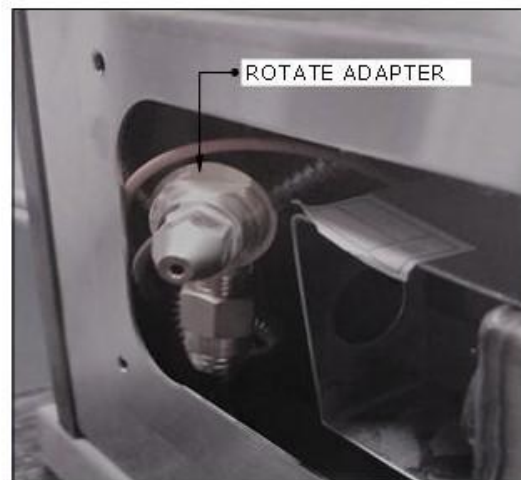
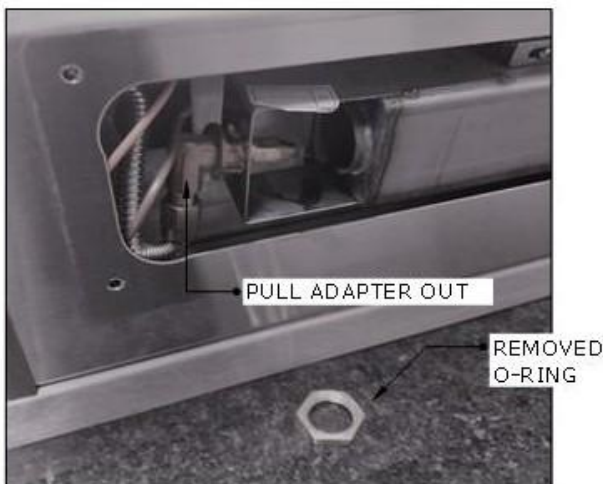

A. If you are converting from LP to NG, use #50 Drill Bit and drill out the center flare hole making it larger like shown.

b. If you are converting from NG to LP, you must remove the Flare and replace with new Flare with smaller Orifice hole for LP.

GAS CONVERSION – Convert NG to LP

The Following section is for converting a Ruby Grill from **Natural Gas to Liquid Propane ONLY**, if you are converting from Liquid Propane to Natural Gas, skip this section and continue onto the next page.

1. REMOVE ALL REMAINING VALVES AND SWAP VALVE FOR OTHER GAS TYPE FOR NG TO LP

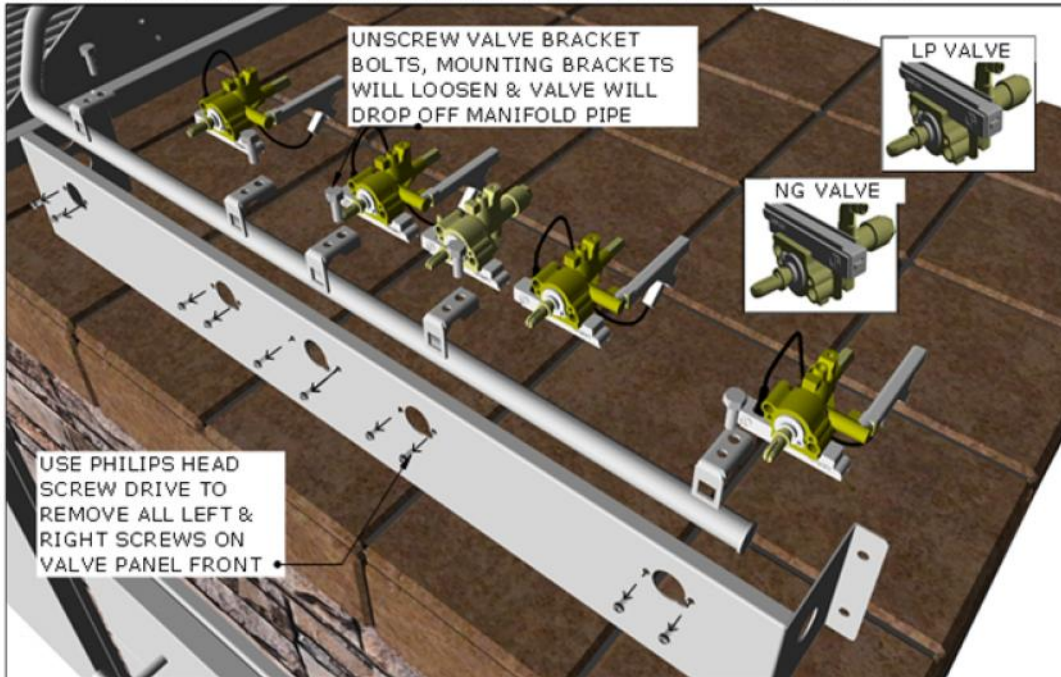

2. LOCATE CONNECTION AT END OF MAINFOLD PIPE, SCREW ON 1/2" TO 3/8" FLARE ADAPTER

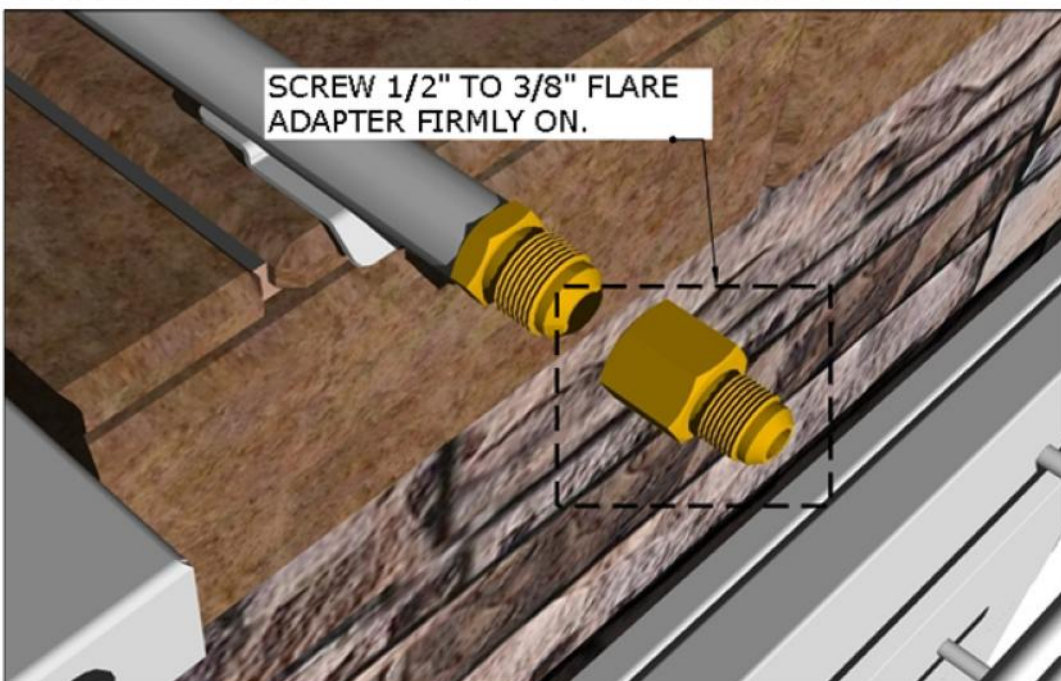

GAS CONVERSION – Convert LP to NG

The Following section is for converting a Ruby Grill from **Liquid Propane to Natural Gas ONLY**, if you are converting from Natural Gas to Liquid Propane, skip this section and refer to page 38.

1. USING A #50 SIZE DRILL BIT, DRILL OPEN THE TIP OF EACH VALVE ORIFICE END

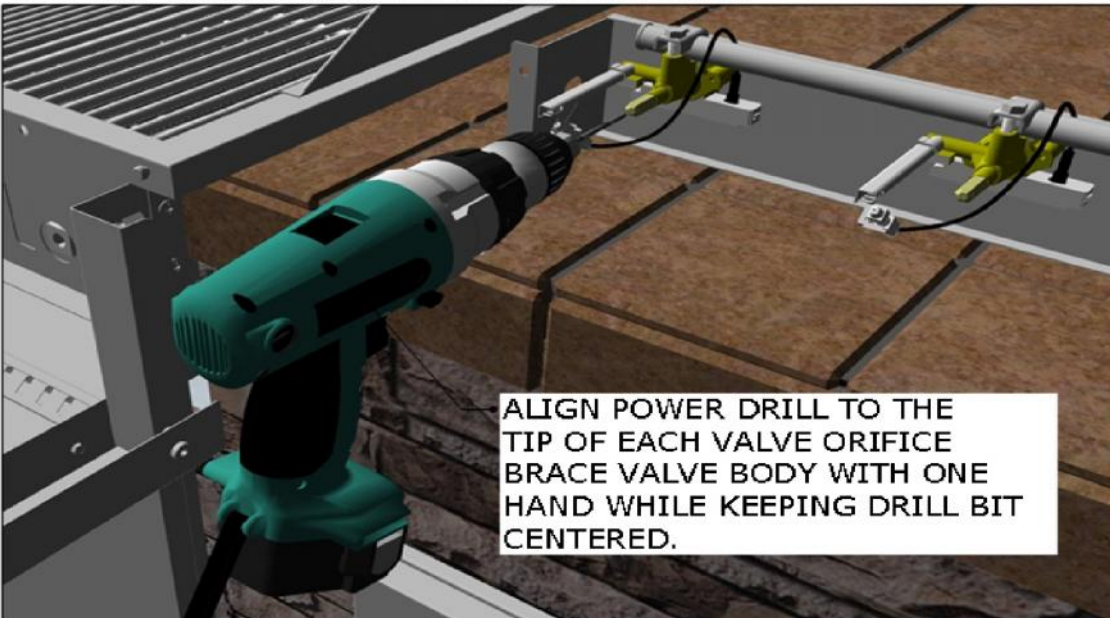

2. PAY CLOSE ATTENTION TO NOT OVERDRILL EACH HOLE, BLOW OUT ANY EXCESS DEBRIS

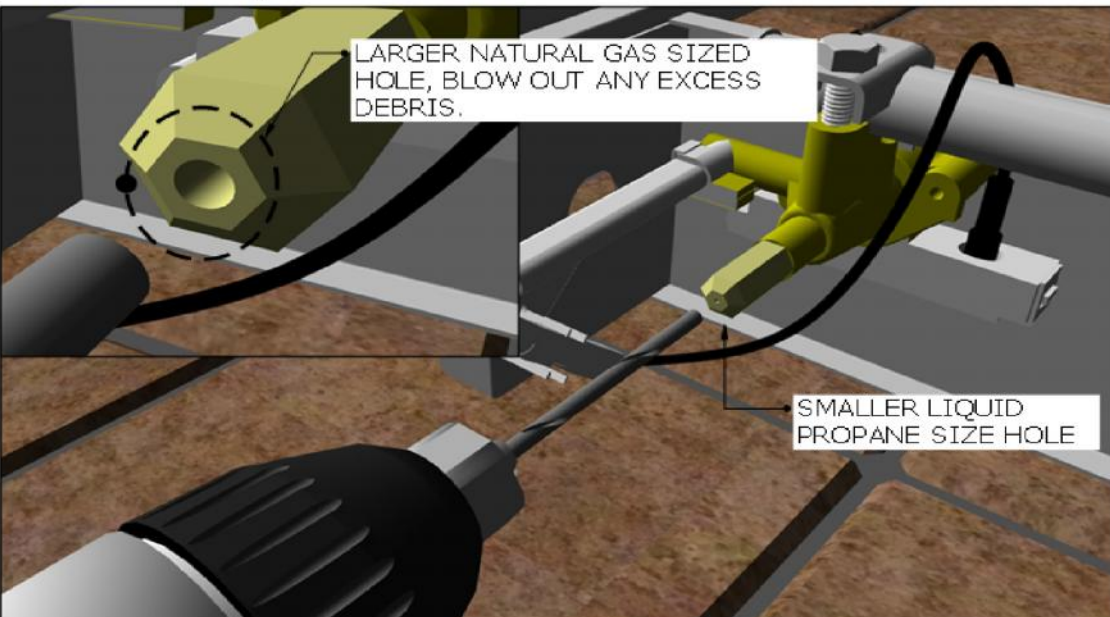

GAS CONVERSION – Convert LP to NG

3. UNSCREW THE CURRENT 3/8" INCH FLARE NIPPLE FROM BACK OF GAS MANIFOLD PIPE

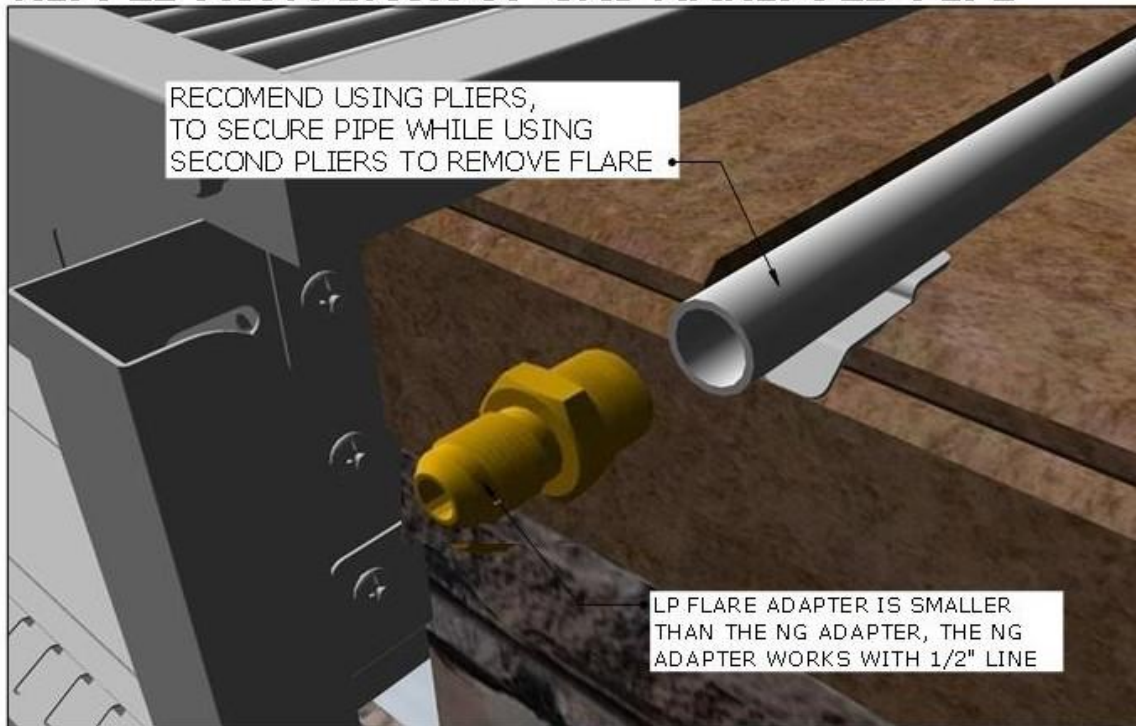

4. REPLACE WITH NEW 1/2" INCH FLARE NIPPLE, USE LOCKTIGHT OR EQUIVELANT ON THREAD

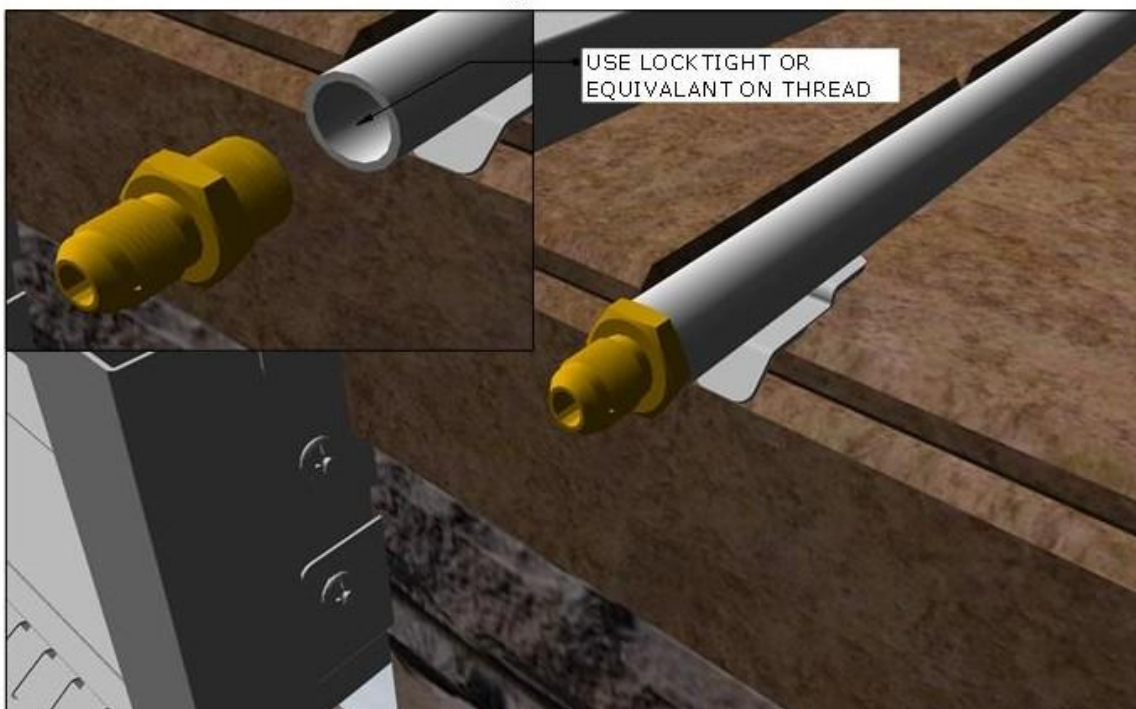

SUNSTONE RUBY SERIES GRILL WARRANTY

“ALL WARRANTIES ARE VOID IF GRILL IS NOT INSTALLED ACCORDING TO SUNSTONE’S BASIC INSTALLATION GUIDELINES, SEE PAGES 9 THRU 13”

WARRANTY ON PARTS

- **MAIN BURNERS ----- LIMITED LIFETIME, with THREE YEAR GUARANTEE**
- **COOKING GRATES ----- LIMITED LIFETIME**
- **FLAVORIZER GRIDS ----- LIMITED LIFETIME**
- **FIREBOX & COMPONENTS ----- LIMITED LIFETIME**
- **VALVES, KNOBS, LIGHTS & ALL OTHER PARTS ----- 1 YEAR WARRANTY**

LIMITED LIFETIME WARRANTY

Stainless steel burner, Cooking Grids, Flavorizer Grids, Stainless Steel Housings (including liners, frames, ovens and barbecue faces), to be from defects in material and workmanship when subjected to normal domestic use and service for the lifetime of the original purchaser. This warranty does not include discoloration, surface corrosion, Burn Through and scratches which may occur during regular use. (See supporting burner three-year warranty below)

THREE YEAR BURNER GUARANTEE

This warranty covers the burner for the First Three Years against surface corrosion and Burn Through, which is the most common reason for replacement of this part and is what most other manufactures do not cover for. The most common reason this occurs is through the use of High Cooking Temperatures, Excessive Humidity, Chlorine, and Salt that can affect the stainless-steel components. This warranty does not cover the burner in Commercial or Residential Communities, also for negligent use or misuse of the product, use with improper fuel/gas supply, and use contrary with operating instructions.

LIMITED ONE-YEAR WARRANTY

All other grill components including knobs, valves, tubing, light assembly, and covers are warranted to be free from defects in material and workmanship for a period of one year from the original date of purchase.

LIMITATIONS & EXCLUSIONS

1. *RUBY GRILL warranty applies only to the original purchaser and may not be transferred.*
2. *RUBY GRILL warranty is in lieu of all other warranties expressed or implied and all other obligations or liabilities related to the sale or use of its grill products.*
3. *RUBY GRILL warranty shall not apply and SUNSTONE METAL PRODUCTS LLC. Is not responsible for damage resulting from misuse, abuse, alteration of or tampering with the appliance, accident, hostile environment, flare-up fires, improper installation, or installation not in accordance with the instructions contained in the User Manual, or the local codes.*
4. *SUNSTONE METAL PRODUCTS LLC. shall not be liable for incidental, consequential, special or contingent damages resulting from its breach of this written warranty or any implied warranty.*
5. *Some states do not allow limitations on how long an implied warranty lasts, or the exclusions of or limitations on Consequential damages. This warranty gives you specific legal rights and you may have other rights, which vary from state to state.*
6. *No one has the authority to add to or vary RUBY GRILL warranty, or to create for SUNSTONE METAL PRODUCTS LLC. any other obligation or liability in connection with the sale or use of its products.*

WHAT IS NOT COVERED & INTERNET PURCHASE DISCLAIMER

1. *Shall not be responsible for and shall not pay for the following Installation or start-up.*
2. *Service by an unauthorized service provider;*
3. *Damage or repair due to service by an unauthorized service provider or use of unauthorized parts.*
4. *Damage caused by accidents, abuse, alteration, misuse, installation that is not in accordance with the instructions contained in the User Manual, or local codes.*
5. *To correct normal adjustments or settings, due to improper installation, commissioning or local gas supply properties.*
6. *Shipping and handling costs, export duties, or installation cost.*
7. *The cost of service calls to diagnose trouble; or Removal or re-installation cost.*